

9022-20-08

Steel, ISO 1179 BSPP Port/Line Union, 1-1/4-11 Male BSPP 60° Line/Port x 1/2-14 Male BSPP 60° Line/Port

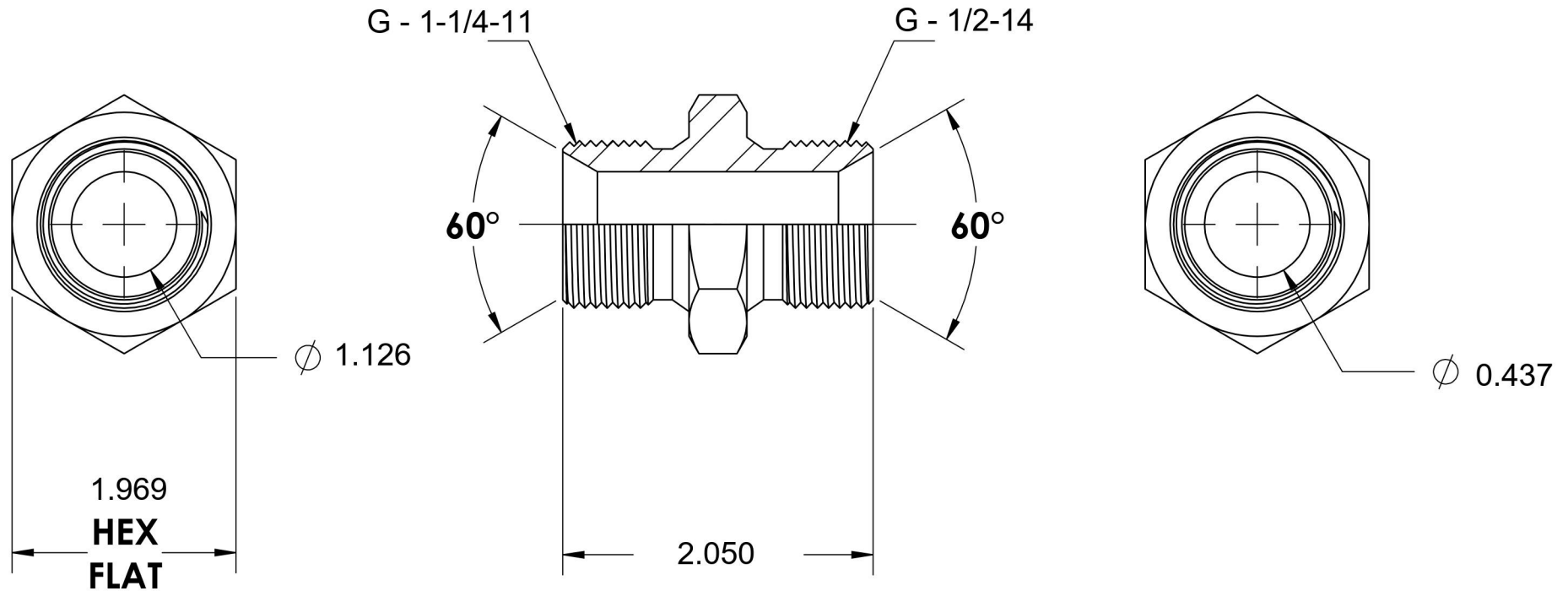
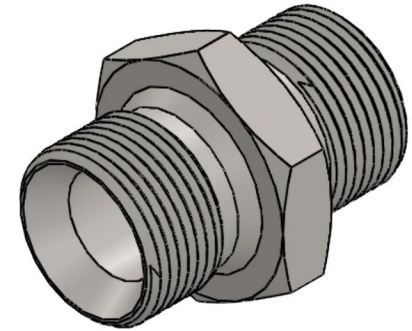

6701 Cochran Road
Solon, Ohio 44139
Phone: (440) 248-1880
Toll Free: 1-888-331-1523

Temperature Rating

-65°F to 500°F

Pressure Rating

1500 psi

Material

C1045/12L14 Steel

Finish

Trivalent Zinc

Industry Standards

ISO 1179, ISO 8434-6
ASTM B633

Series

9022

Series Description

ISO 1179 BSPP
Port/Line Union