

9522-P-32-SS

Stainless Steel, ISO 1179 BSPP Hex Head Port Plug, 2-11 Male BSPP 60° Line/Port

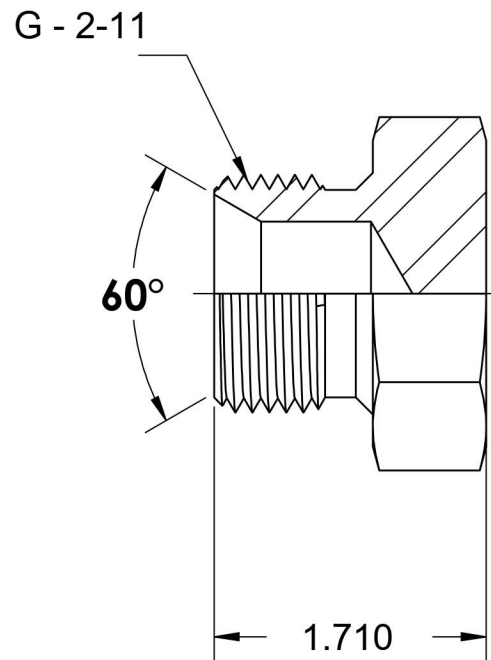
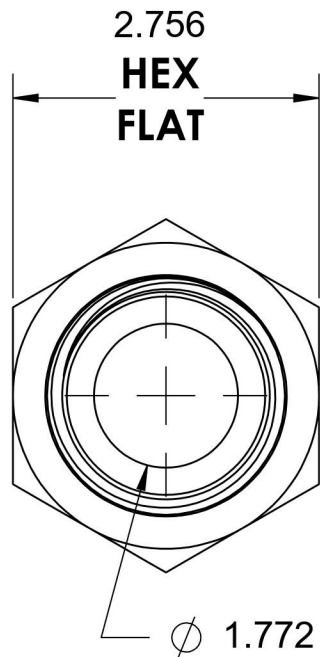
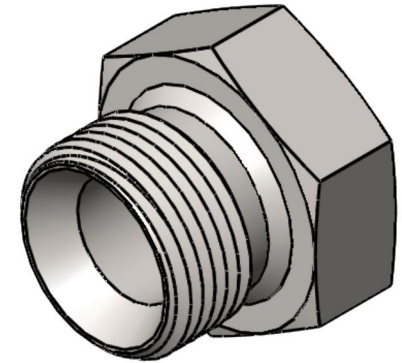

6701 Cochran Road
Solon, Ohio 44139
Phone: (440) 248-1880
Toll Free: 1-888-331-1523

Temperature Rating

-425°F to 1200°F

Pressure Rating

1000 psi

Material

316/316L Stainless Steel

Finish

Passivated

Industry Standards

ISO 1179

Series

9522-P-SS

Series Description

ISO 1179 BSPP Hex Head Port Plug