

7005-20-S38-52

Steel, SAE J514 37° Flare/ISO 8434-1 Heavy Series Male Adapter, 1-1/4" Male JIC x M52X2.0 Male DIN

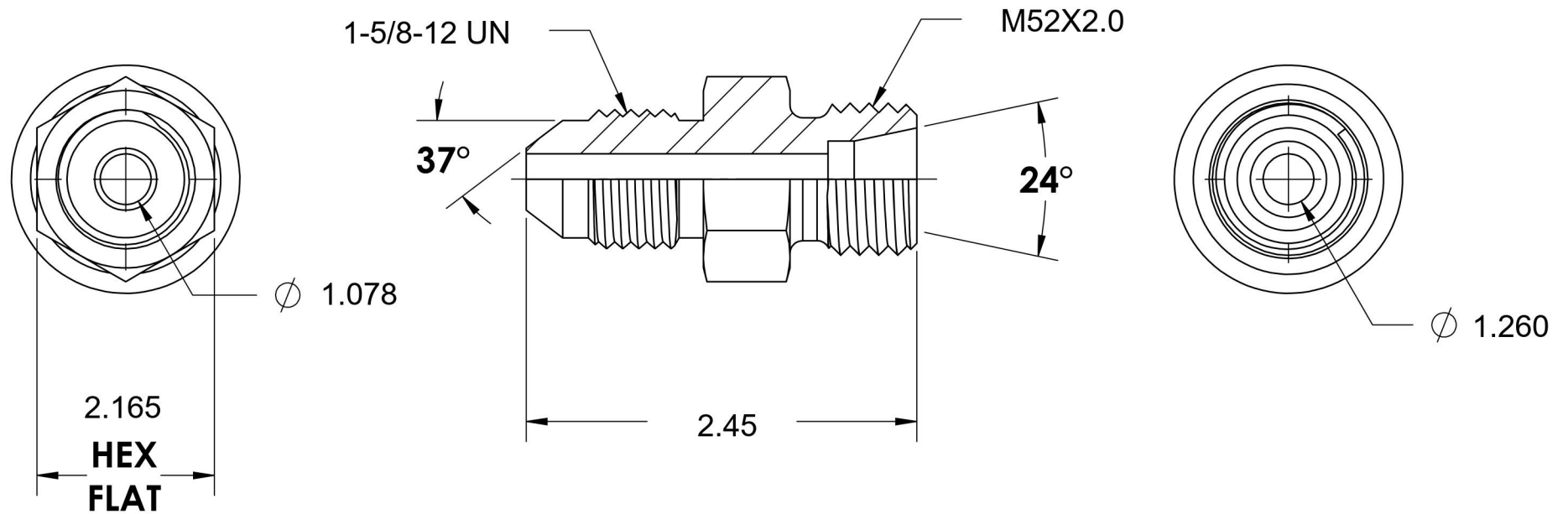

6701 Cochran Road
Solon, Ohio 44139
Phone: (440) 248-1880
Toll Free: 1-888-331-1523

Temperature Rating -65°F to 500°F	Material C1045 / 12L14 Steel	Industry Standards SAE J514, ISO 8434-1	Series 7005-DIN HEAVY
Pressure Rating 4000 psi	Finish Trivalent Zinc	Industry Standards DIN 2353, ASTM B633	Series Description SAE J514 37° Flare/ISO 8434-1 Heavy Series Male Adapter