

6500-10-08-FG

Steel, SAE J514 37° Flare 90° Swivel Elbow, 5/8" Male JIC x 1/2" Female JIC Swivel

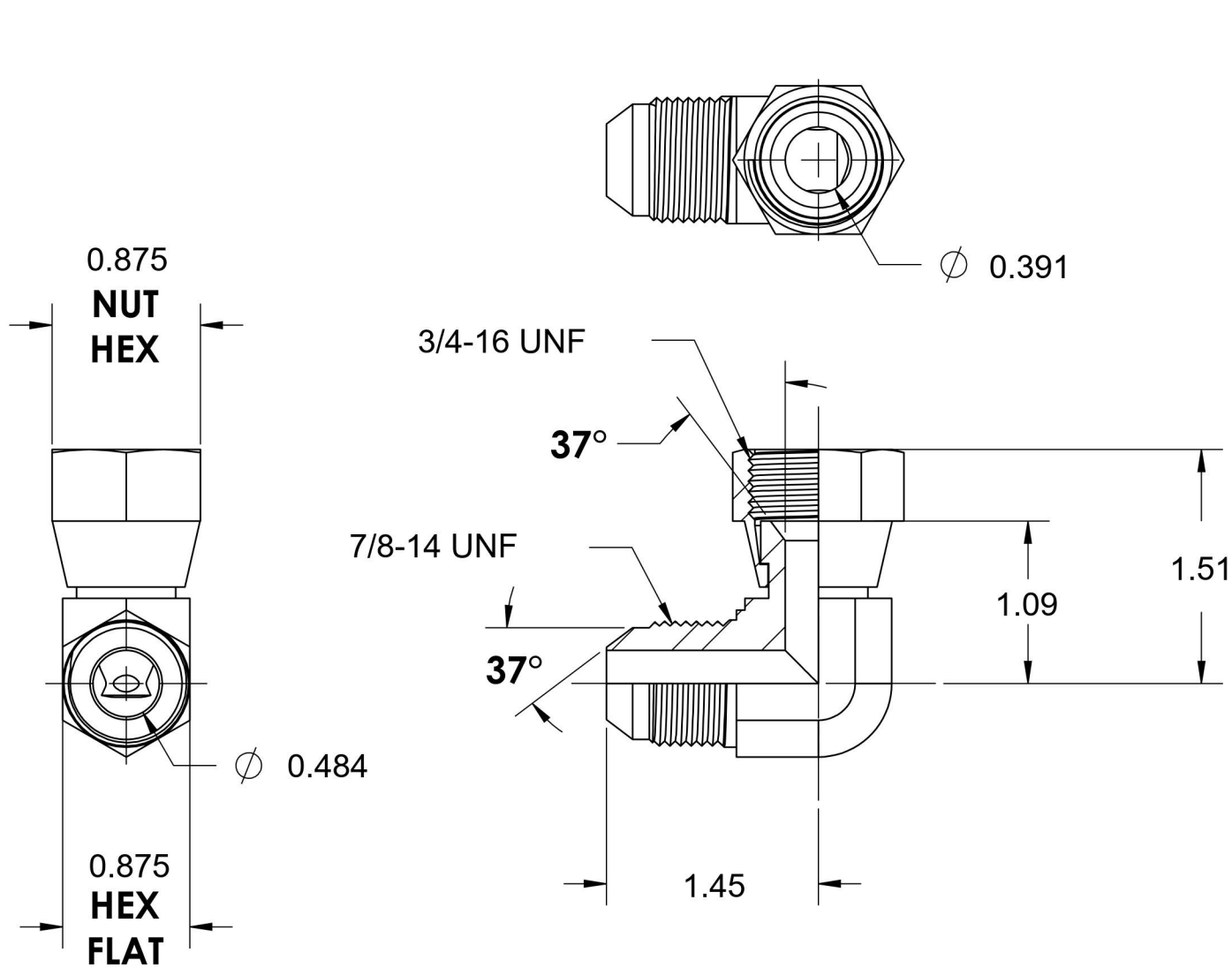

6701 Cochran Road
Solon, Ohio 44139
Phone: (440) 248-1880
Toll Free: 1-888-331-1523

Temperature Rating -65°F to 500°F	Material C1045 Steel	Industry Standards SAE J514, ASTM B633	Series 6500-FG
Pressure Rating 5000 psi	Finish Trivalent Zinc		Series Description SAE J514 37° Flare 90° Swivel Elbow