

# FS2403-10-10

Steel, SAE J1453 O-Ring Face Seal Union, 5/8" Male ORFS x 5/8" Male ORFS

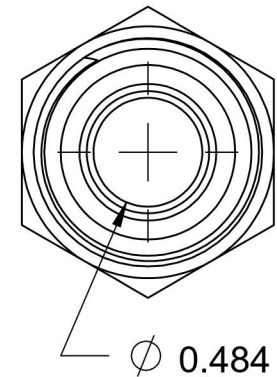
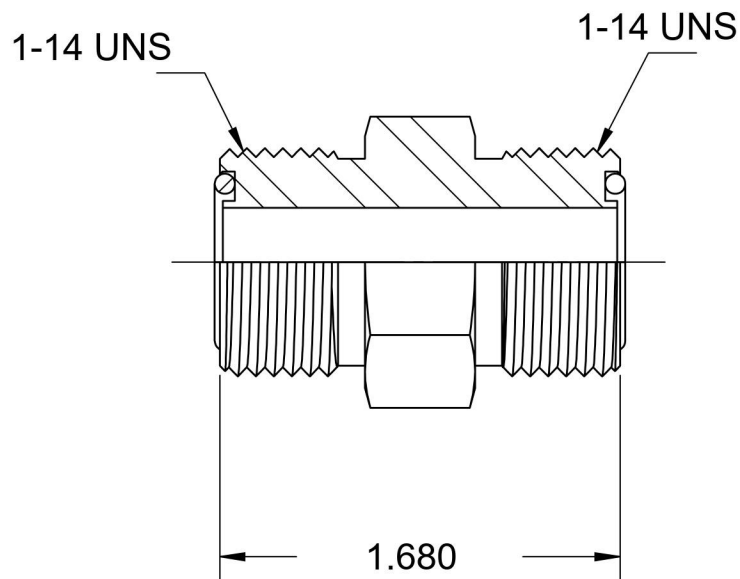
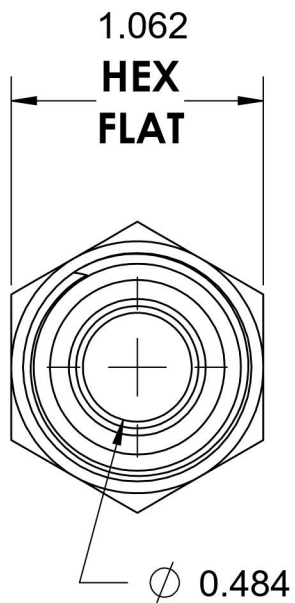
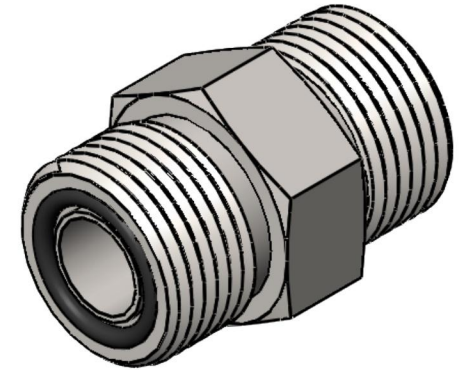

6701 Cochran Road  
Solon, Ohio 44139  
Phone: (440) 248-1880  
Toll Free: 1-888-331-1523

#### Temperature Rating

-40°F to 250°F

#### Pressure Rating

6000 psi

#### Material

C1045/12L14 Steel

#### Finish

Trivalent Zinc

#### Industry Standards

SAE J1453, SAE J515  
ASTM B633

#### Series

FS2403

#### Series Description

SAE J1453 O-Ring Face Seal Union