

# FS2501-06-04-SS

Stainless Steel, SAE J1453 O-Ring Face Seal 90° Male Elbow, 3/8" Male ORFS x 1/4" Male NPTF 30°

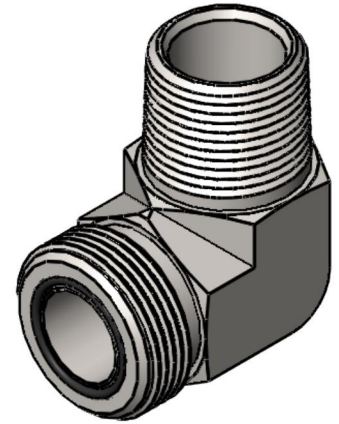
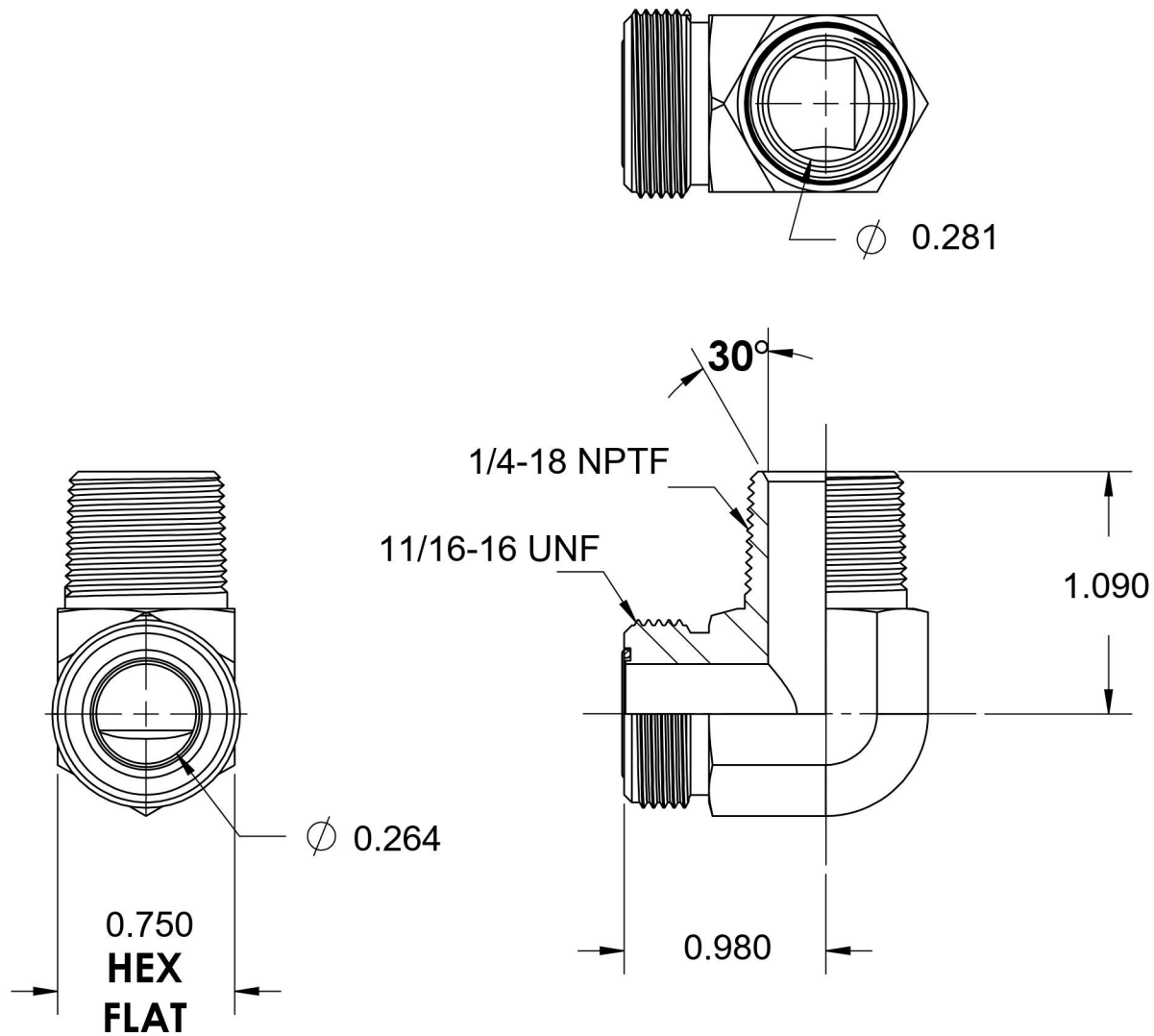

6701 Cochran Road  
Solon, Ohio 44139  
Phone: (440) 248-1880  
Toll Free: 1-888-331-1523

<b>Temperature Rating</b>	<b>Material</b>	<b>Industry Standards</b>	<b>Series</b>
-40°F to 250°F	316/316L Stainless Steel	SAE J1453, SAE J476 SAE J515	FS2501-SS
<b>Pressure Rating</b>	<b>Finish</b>		<b>Series Description</b>
6000 psi	Passivated		SAE J1453 O-Ring Face Seal 90° Male Elbow