

0319-05-B

Brass, SAE J514 37° Flare Tube Sleeve, 5/16" JIC Tube Sleeve

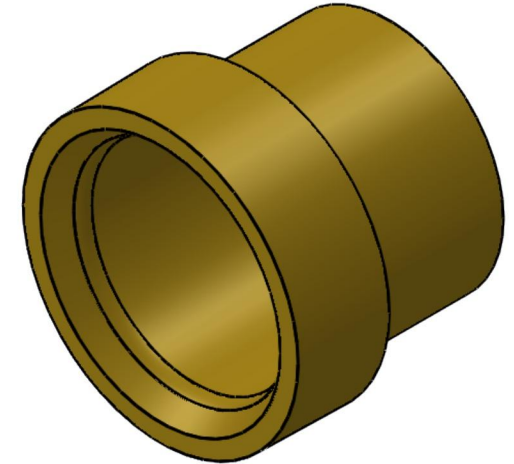
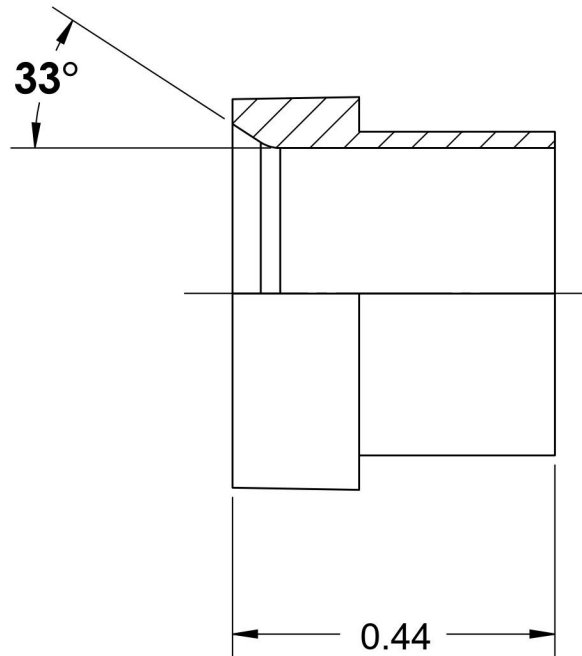
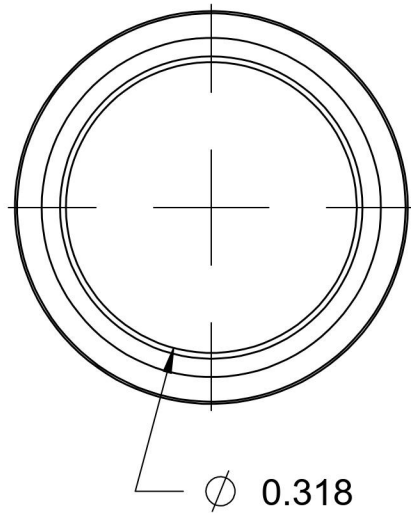

6701 Cochran Road
Solon, Ohio 44139
Phone: (440) 248-1880
Toll Free: 1-888-331-1523

Temperature Rating -325°F to 400°F	Material C36000 Brass	Industry Standards SAE J514	Series 0319-B
Pressure Rating Not Applicable	Finish Natural Finish		Series Description SAE J514 37° Flare Tube Sleeve