

1503-08-06-FG

Steel, SAE J514 NPSM Swivel 45° Male Elbow, 1/2" Male NPTF 30° x 3/8" Female NPSM Swivel

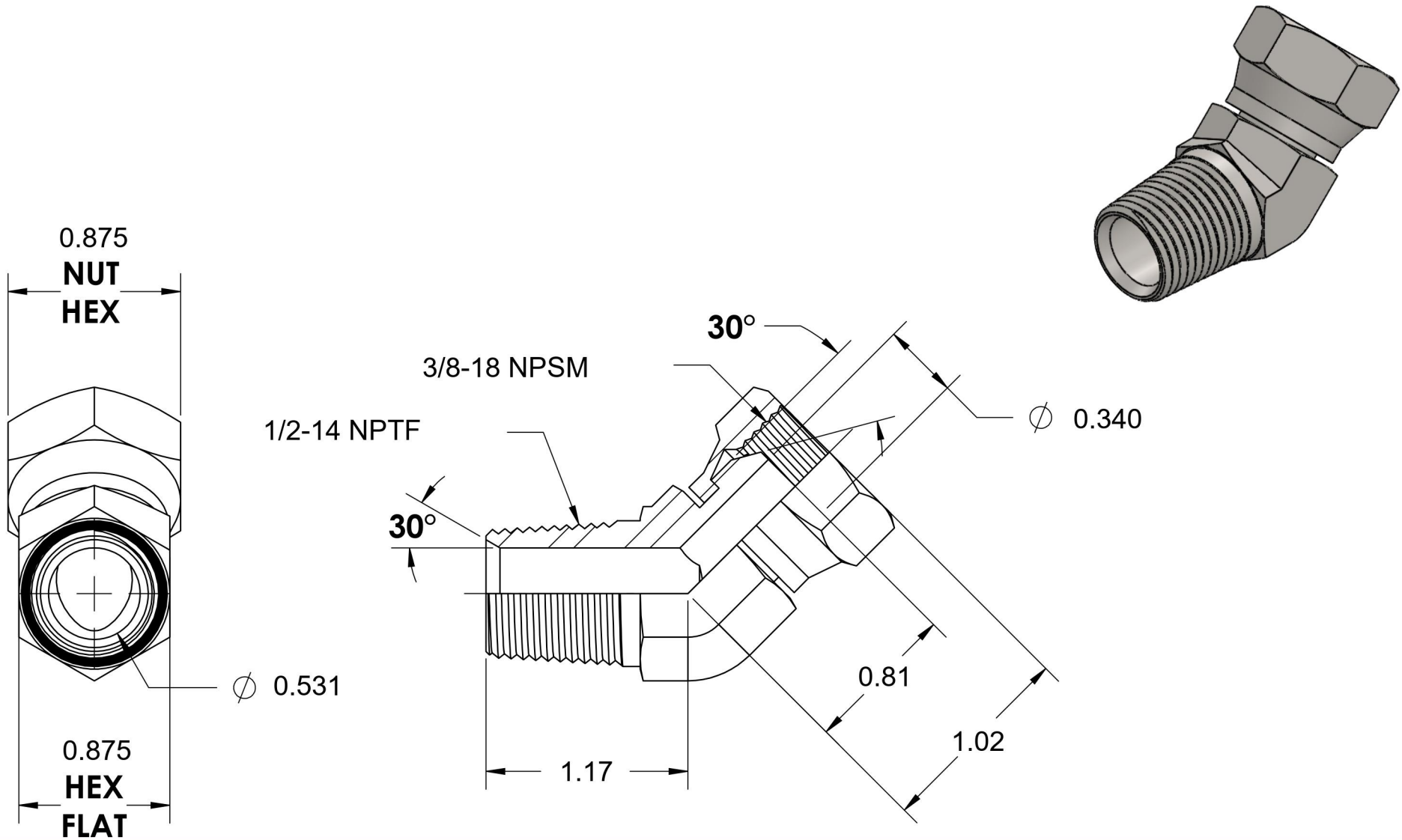

6701 Cochran Road
Solon, Ohio 44139
Phone: (440) 248-1880
Toll Free: 1-888-331-1523

Temperature Rating	Material	Industry Standards	Series
-65°F to 500°F	C1045 Steel	SAE J514, SAE J476 ASTM B633	1503-FG
Pressure Rating	Finish		Series Description
5000 psi	Trivalent Zinc		SAE J514 NPSM Swivel 45° Male Elbow