

6805-05-06-NWO-FG

Steel, SAE J1926 Adjustable O-Ring Boss 90° Female Elbow, 1/2-20 Male Adjustable ORB x 3/8" Female NPTF

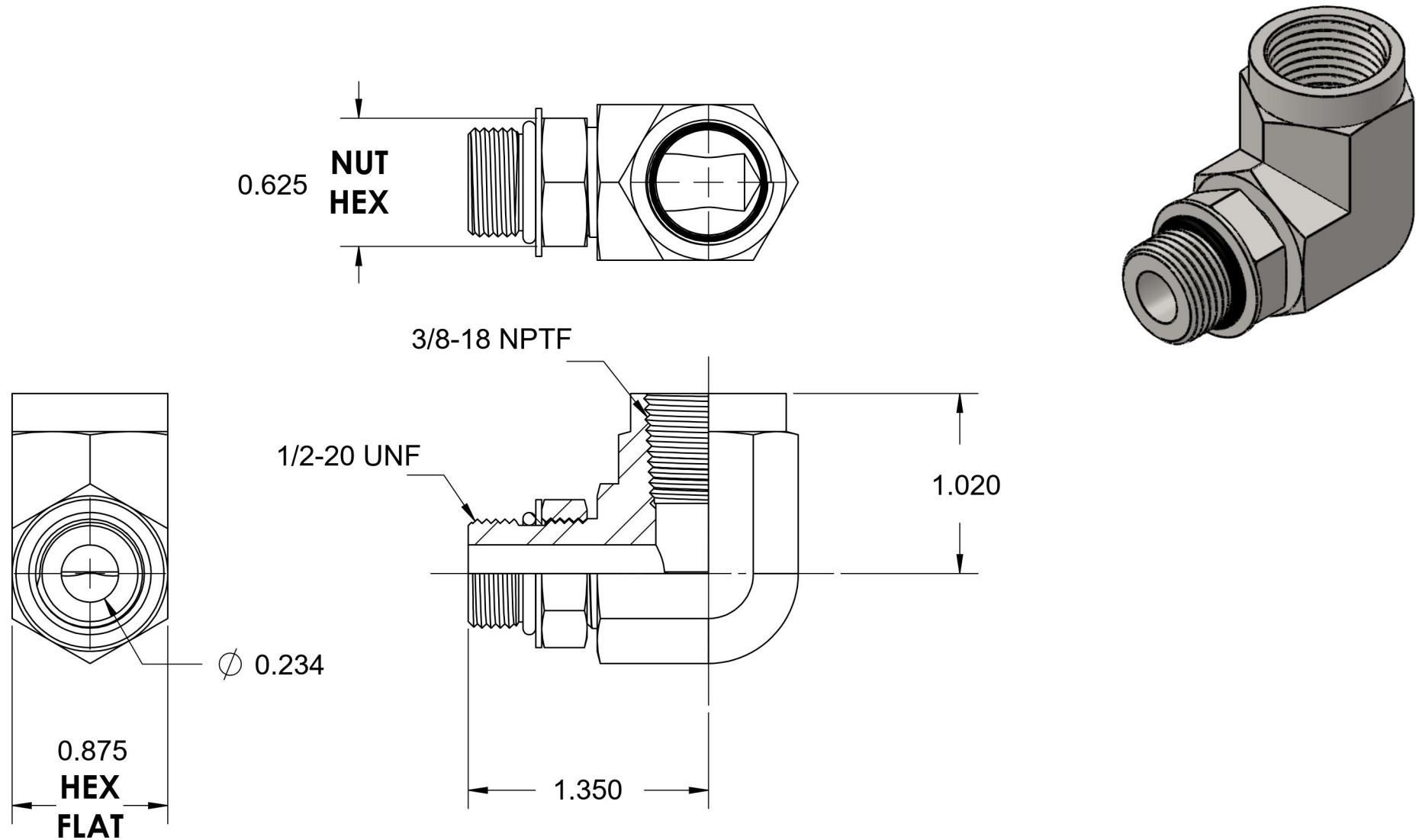

6701 Cochran Road
Solon, Ohio 44139
Phone: (440) 248-1880
Toll Free: 1-888-331-1523

Temperature Rating	Material	Industry Standards	Series
-40°F to 250°F	C1045 Steel	SAE J1926-3, SAE J476 SAE J515, ASTM B633	6805-NWO-FG
Pressure Rating	Finish		Series Description
5000 psi	Trivalent Zinc		SAE J1926 Adjustable O-Ring Boss 90° Female Elbow