

2705-08-06

Steel, SAE J514 Flared Tube Female Bulkhead, 1/2" Female NPTF x 3/8" Male JIC

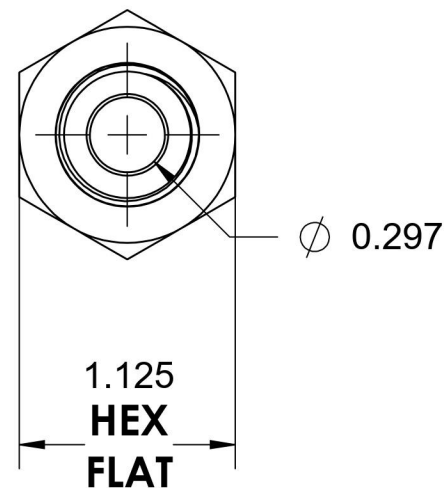
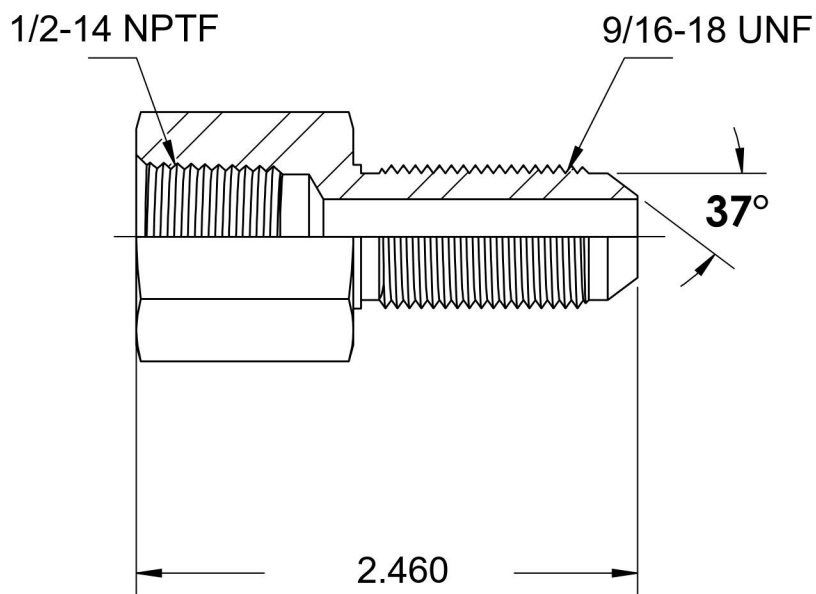
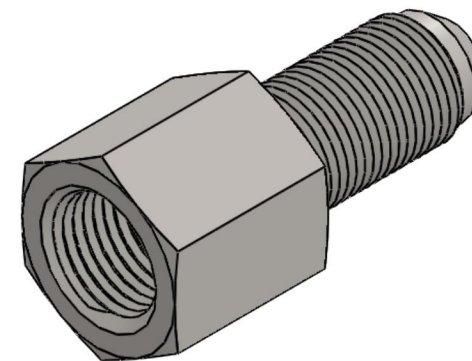

6701 Cochran Road
Solon, Ohio 44139
Phone: (440) 248-1880
Toll Free: 1-888-331-1523

Temperature Rating	Material	Industry Standards	Series
-65°F to 500°F	C1045/12L14 Steel	SAE J514 , SAE J476 ASTM B633	2705
Pressure Rating	Finish		Series Description
6000 psi	Trivalent Zinc		SAE J514 Flared Tube Female Bulkhead