

D0304-C-S06-SS

Stainless Steel, DIN 2353 Blanking Plug, Heavy 6mm Tube OD

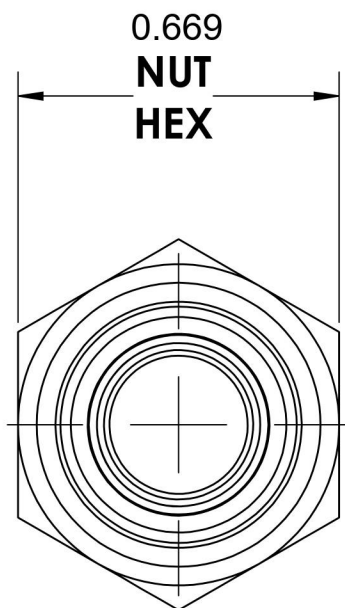

M14X1.5

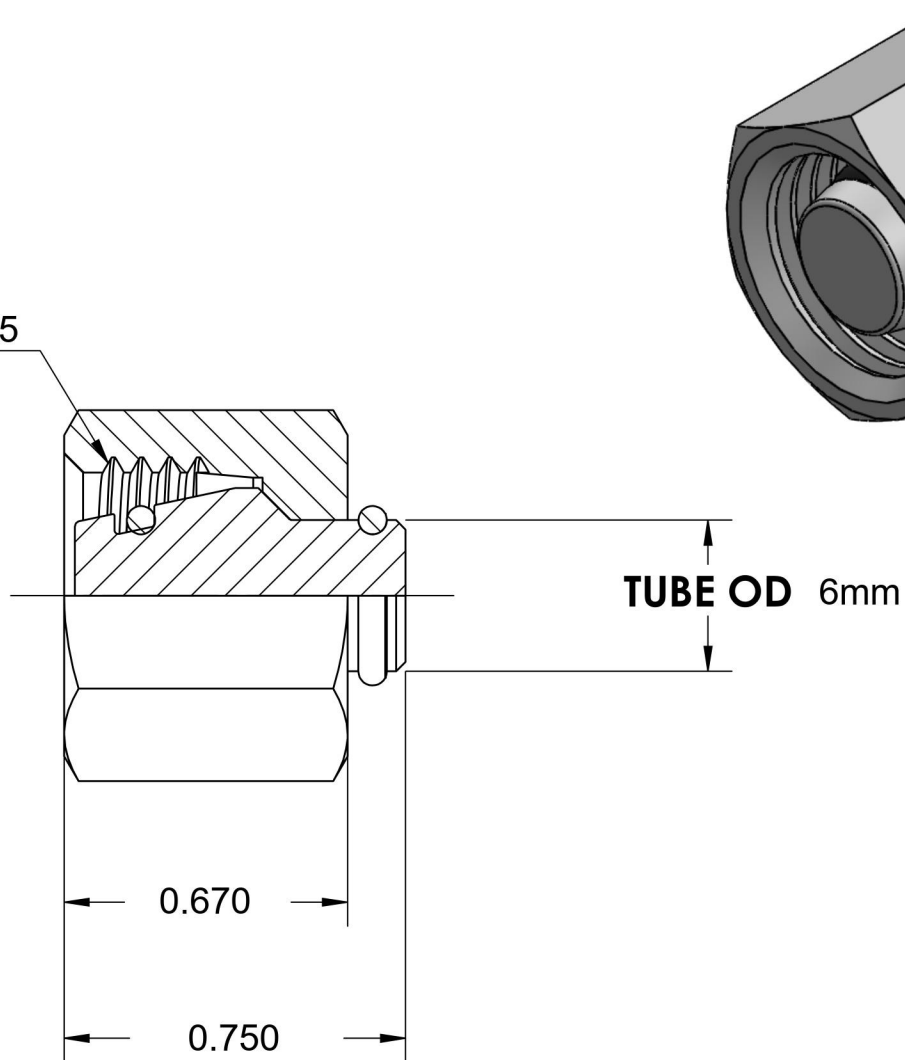

6701 Cochran Road
Solon, Ohio 44139
Phone: (440) 248-1880
Toll Free: 1-888-331-1523

Temperature Rating

-15°F to 400°F

Pressure Rating

Not Available

Material

316Ti Stainless Steel

Finish

Passivated

Industry Standards

DIN 2353, ISO 8434-1

Series

D0304-C-SS

Series Description

DIN 2353 Flareless Tube
Blanking Cap Assembly