

6425-10-10

Steel, SAE J1926 O-Ring Boss Union Coupling, 7/8-14 Female ORB

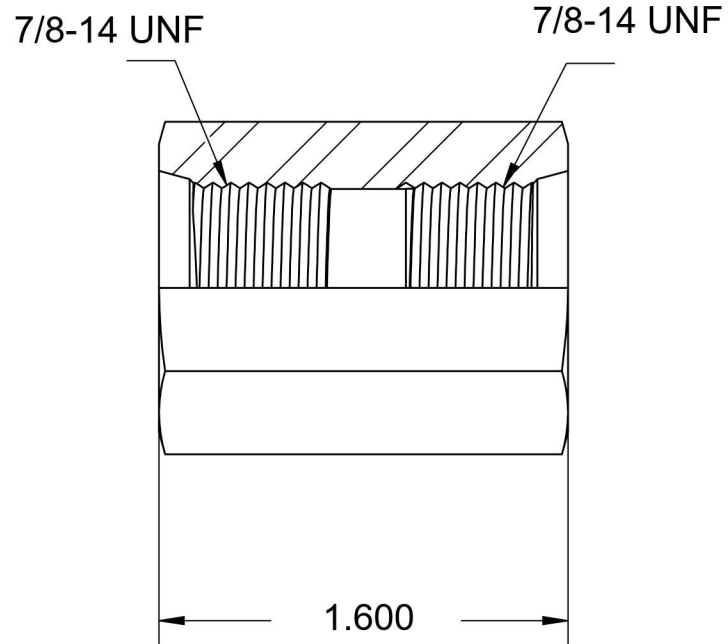
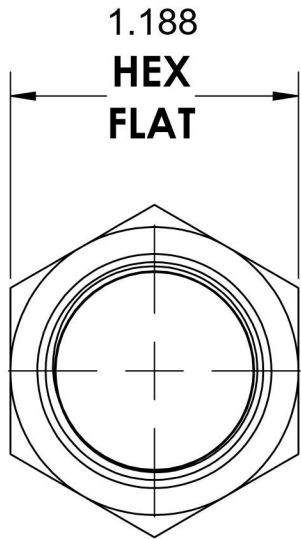
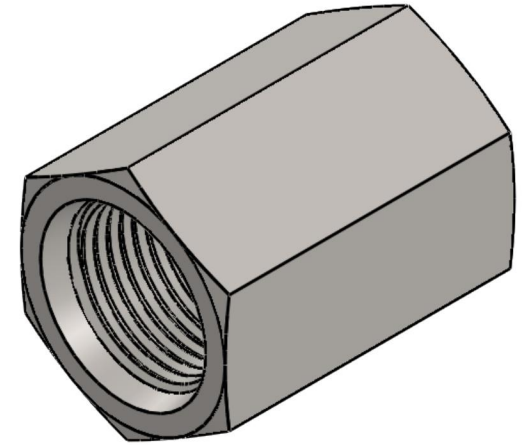

6701 Cochran Road
Solon, Ohio 44139
Phone: (440) 248-1880
Toll Free: 1-888-331-1523

Temperature Rating

-65°F to 500°F

Pressure Rating

4500psi

Material

C1045 Steel

Finish

Trivalent Zinc

Industry Standards

SAE J1926, ASTM B633

Series

6425

Series Description

SAE J1926 O-Ring Boss Union Coupling