

# 7007-10-S20-30

Steel, SAE J514 37° Flare DIN (S) Swivel Adapter, 5/8" Male JIC x M30X2.0 Female DKO Swivel

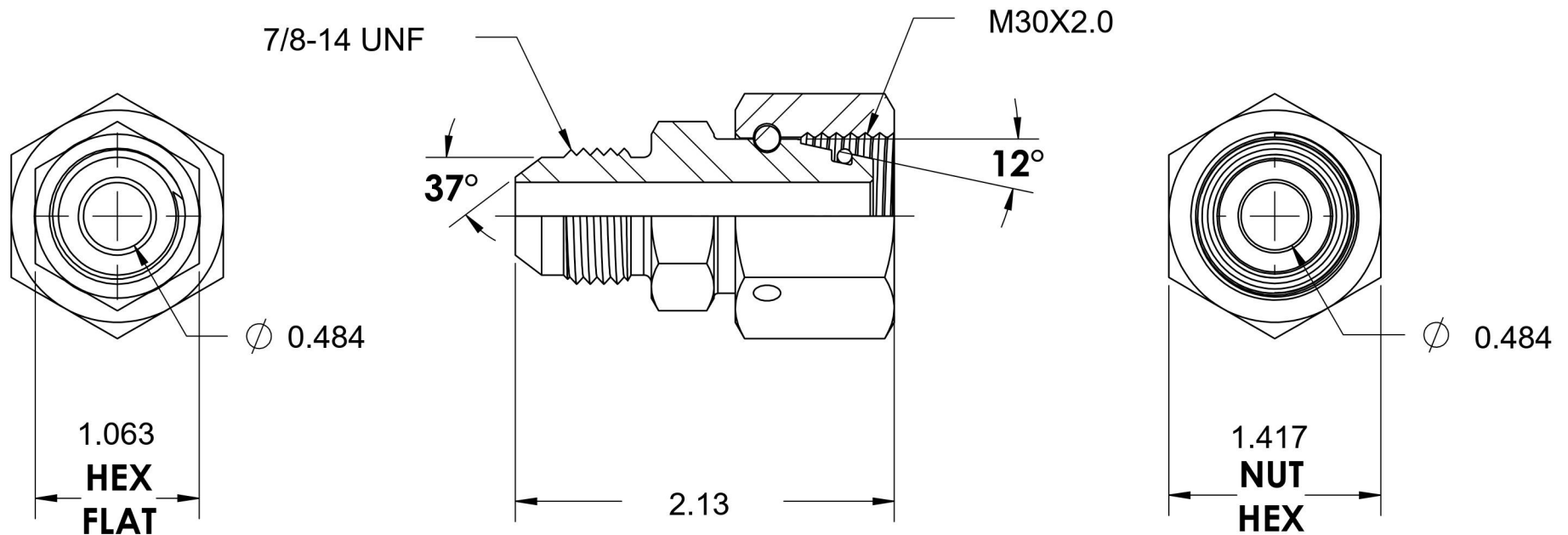

6701 Cochran Road  
Solon, Ohio 44139  
Phone: (440) 248-1880  
Toll Free: 1-888-331-1523

<b>Temperature Rating</b>	<b>Material</b>	<b>Industry Standards</b>	<b>Series</b>
-40°F to 250°F	C1045 / 12L14 Steel	SAE J514, ISO 8434-1	7007-DIN HEAVY
<b>Pressure Rating</b>	<b>Finish</b>	DIN 2353, ASTM B633	<b>Series Description</b>
5000 psi	Trivalent Zinc		SAE J514 37° Flare DIN (S) Swivel Adapter