

# 2501-12-12-SS

Stainless Steel, SAE J514 37° Flare 90° Male Elbow, 3/4" Male JIC x 3/4" Male NPTF 30°

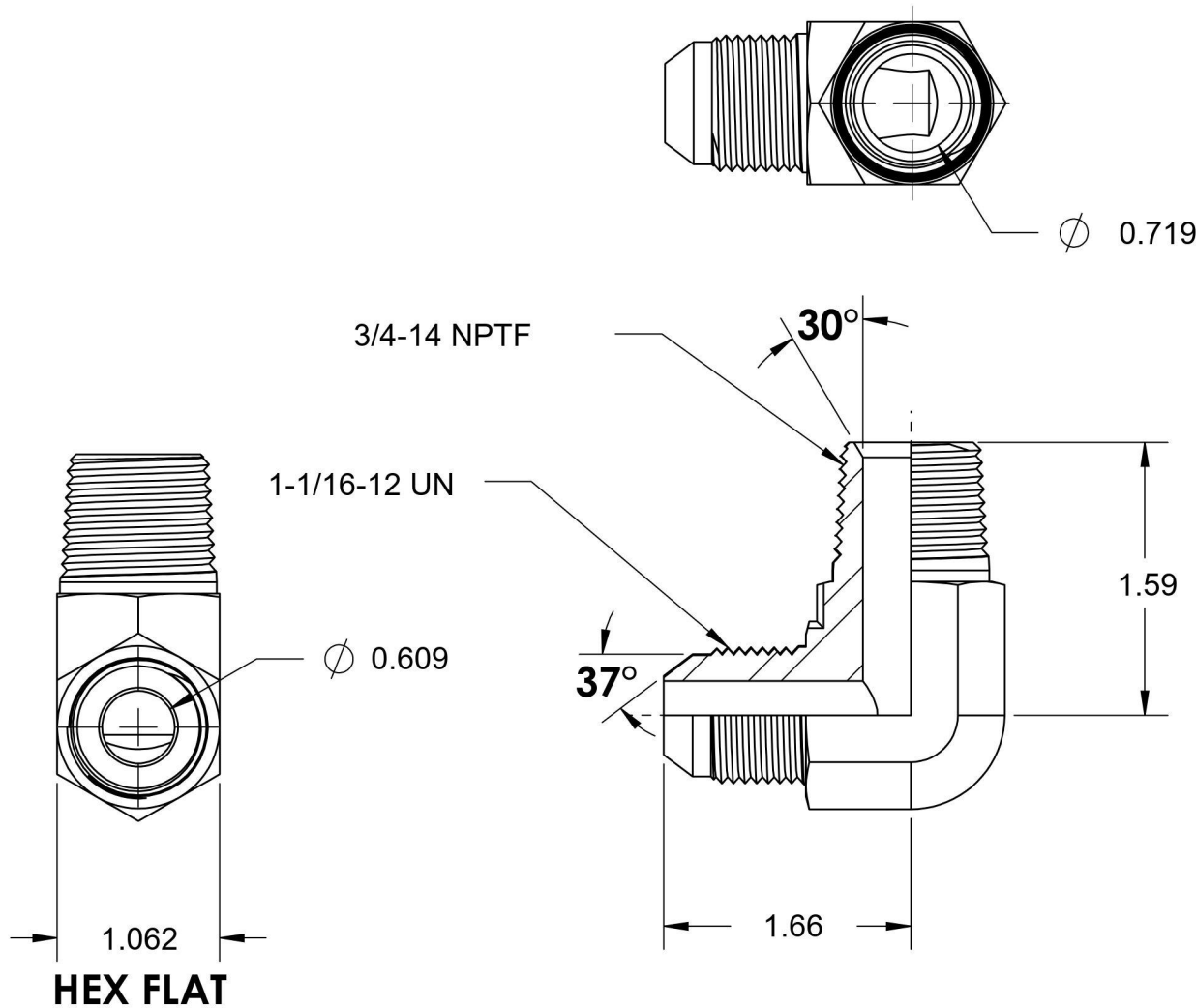

6701 Cochran Road  
Solon, Ohio 44139  
Phone: (440) 248-1880  
Toll Free: 1-888-331-1523

**Temperature Rating**

-425°F to 1200°F

**Pressure Rating**

4000 psi

**Material**

316/316L Stainless Steel

**Finish**

Passivated

**Industry Standards**

SAE J514 , SAE J476

**Series**

2501-SS

**Series Description**

SAE J514 37° Flare 90° Male Elbow