

# 1703-32-24-SS

Stainless Steel, SAE J514 37° Flare 45° Code 61 Flange Swept Elbow, 2" Male JIC x 1-1/2" Split Flange Head

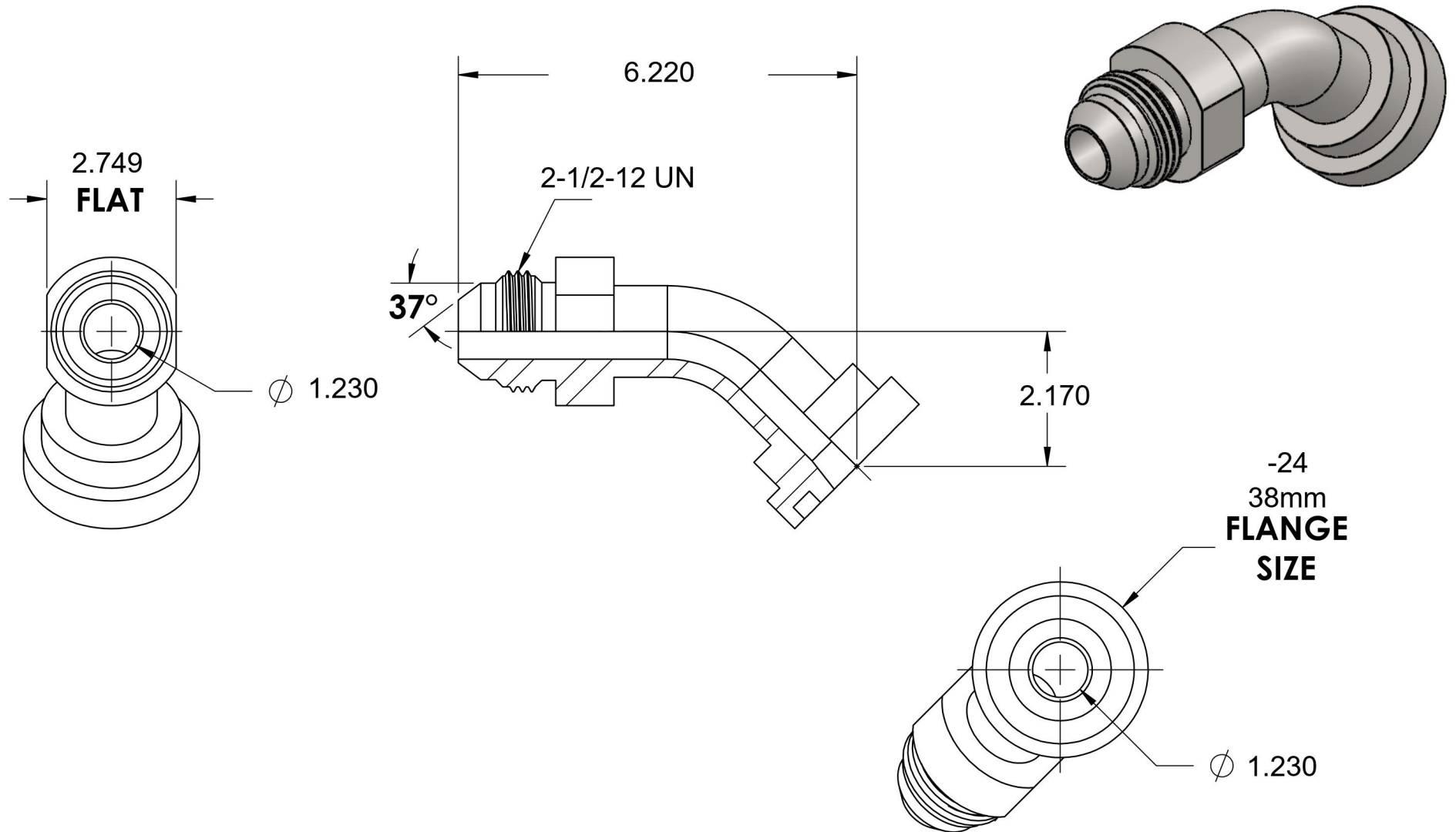

6701 Cochran Road  
Solon, Ohio 44139  
Phone: (440) 248-1880  
Toll Free: 1-888-331-1523

<b>Temperature Rating</b>	<b>Material</b>	<b>Industry Standards</b>	<b>Series</b>
-425°F to 1200°F	316/316L Stainless	SAE J518 Code 61, SAE J514	1703
<b>Pressure Rating</b>	<b>Finish</b>		<b>Series Description</b>
2000psi	Passivation		SAE J514 37° Flare 45° Code 61 Flange Swept Elbow