

7008-06-06

Steel, SAE J514 37° Flare Male JIS Adapter, 3/8" Male JIC x 3/8-19 Male JIS

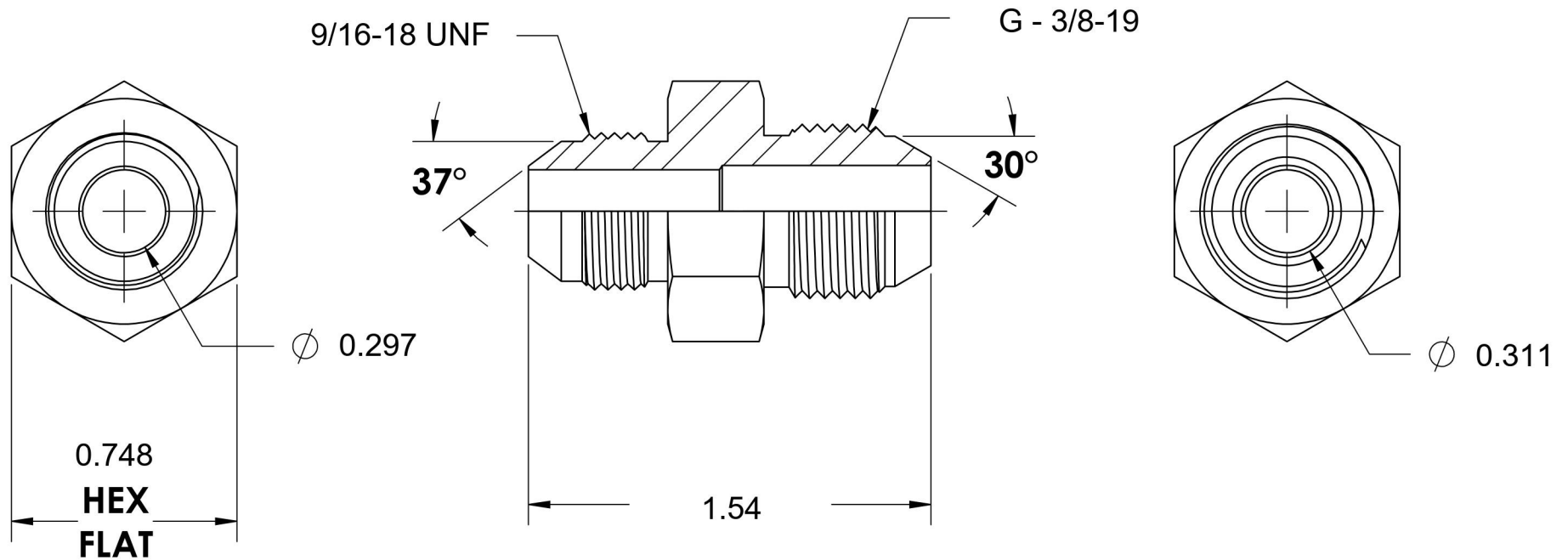
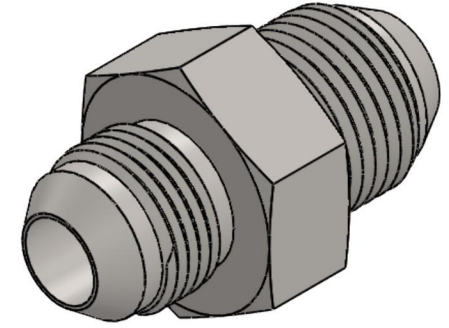

6701 Cochran Road
Solon, Ohio 44139
Phone: (440) 248-1880
Toll Free: 1-888-331-1523

Temperature Rating	Material	Industry Standards	Series
-65°F to 500°F	C1045 / 12L14 Steel	SAE J514, JIS B 0202	7008
Pressure Rating	Finish	ASTM B633	Series Description
5000 psi	Trivalent Zinc		SAE J514 37° Flare Male JIS Adapter