

# 6801-L-10-08-NWO-FG

Steel, SAE J514 37° Flare 90° Long Adjustable Port Elbow, 5/8" Male JIC x 3/4-16 Male Adjustable ORB

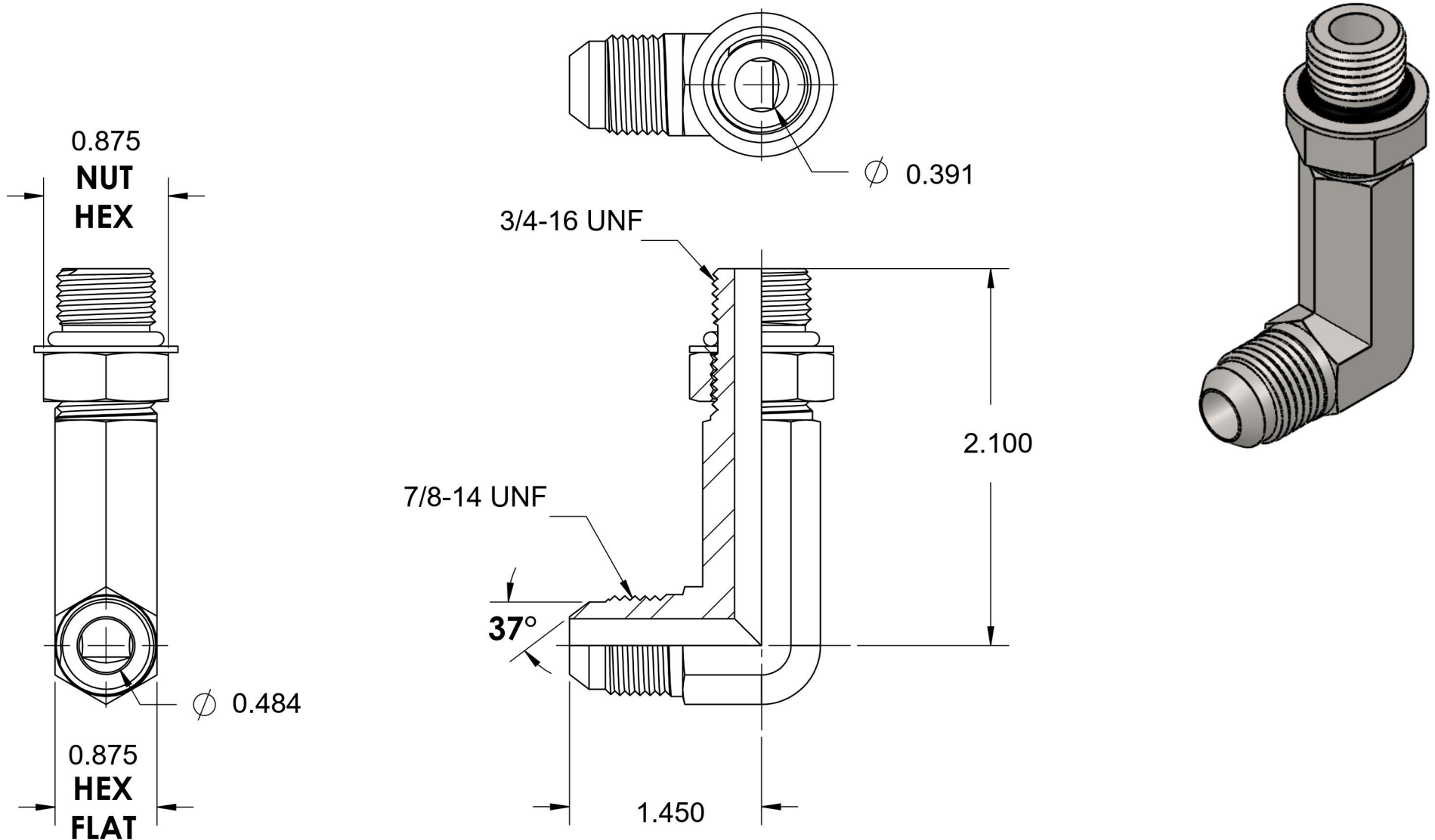

6701 Cochran Road  
Solon, Ohio 44139  
Phone: (440) 248-1880  
Toll Free: 1-888-331-1523

**Temperature Rating**

-40°F to 250°F

**Pressure Rating**

5000psi

**Material**

C1045 Steel

**Finish**

Trivalent Zinc

**Industry Standards**

SAE J514, SAE J1926-3  
ASTM B633

**Series**

6801-L-NWO-FG

**Series Description**

SAE J514 37° Flare 90° Long  
Adjustable Port Elbow