

6574-20-20-08

Steel, SAE J514 37° Flare Swivel Adapter NPT Diagnostic Port, 1-1/4" Male JIC x 1-1/4" Female JIC Swivel x 1/4" FNPT Diagnostic Port

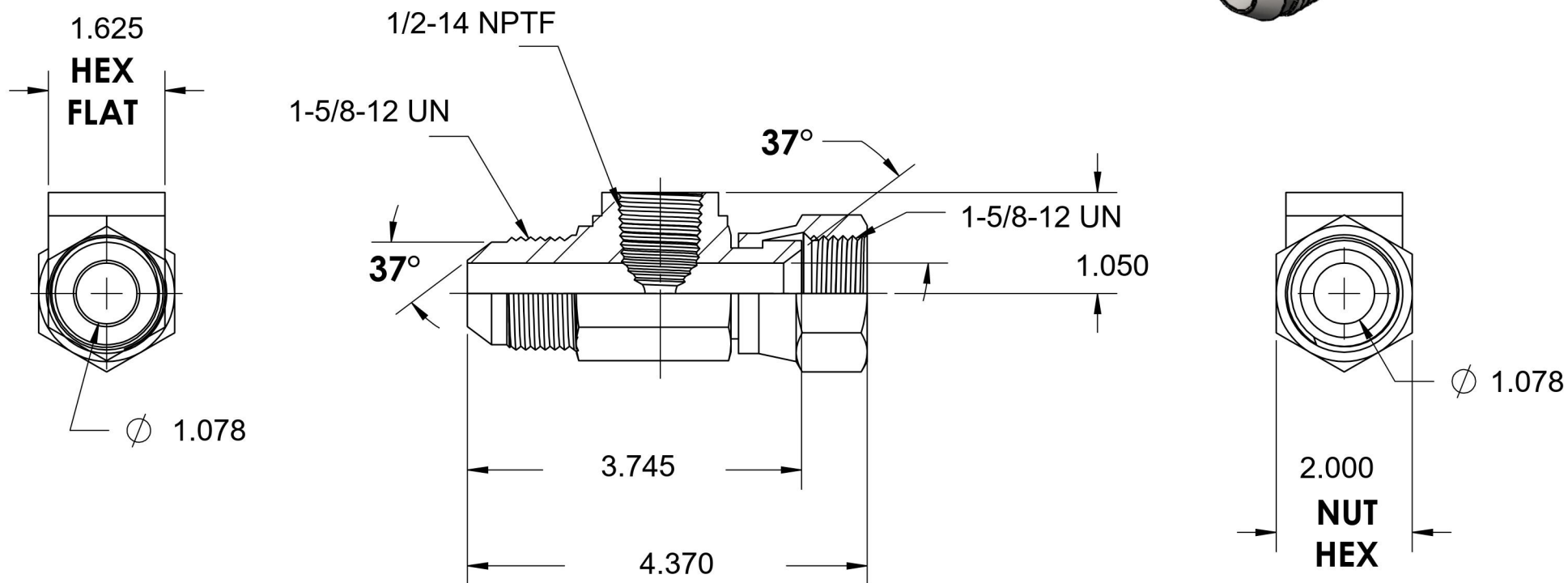
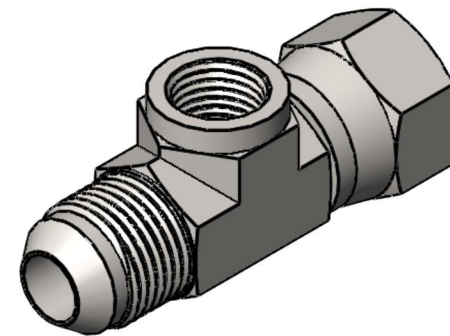

6701 Cochran Road
Solon, Ohio 44139
Phone: (440) 248-1880
Toll Free: 1-888-331-1523

Temperature Rating

-65°F to 500°F

Pressure Rating

1500 psi

Material

C1045/12L14 Steel

Finish

Trivalent Zinc

Industry Standards

SAE J514, SAE J1926-1
ASTM B633

Series

6574

Series Description

SAE J514 37° Flare Swivel Adapter
NPT Diagnostic Port