

7001-06-20

Steel, SAE J514 37° Flare Male Metric Type (G) Port Adapter, 3/8" Male JIC x M20X1.5 Male Metric ORR

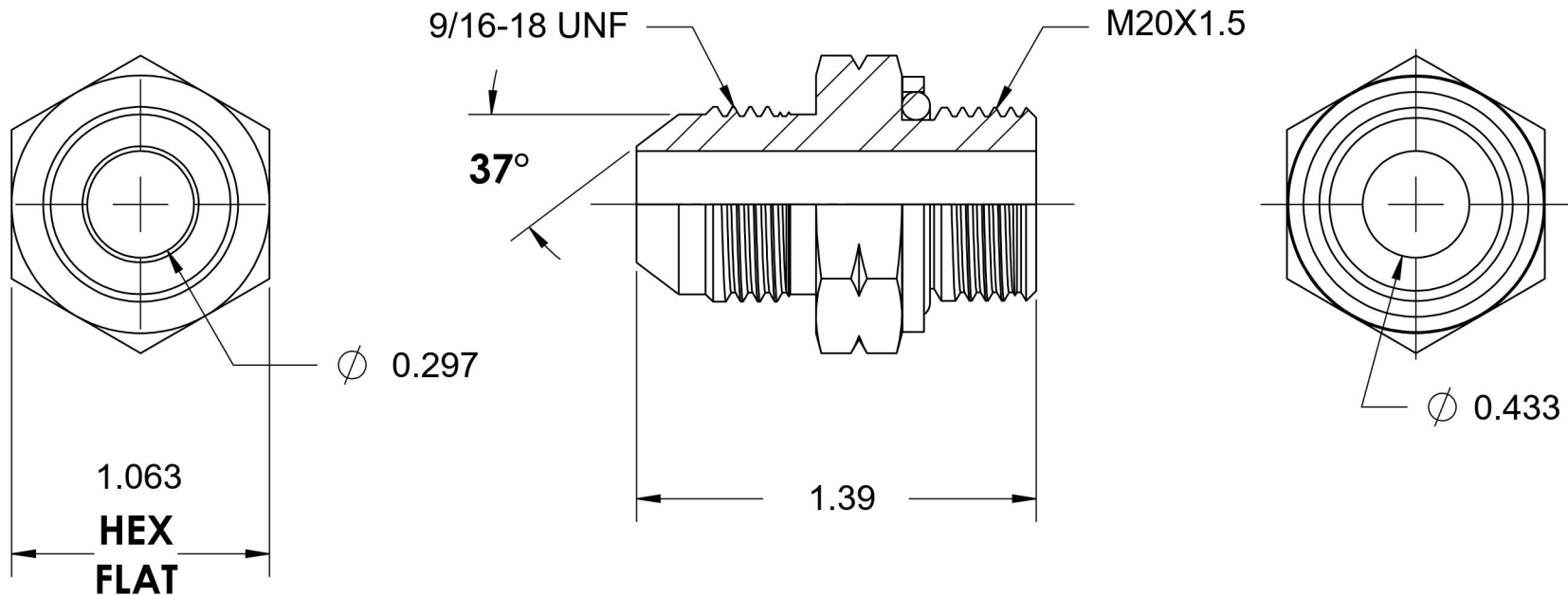

6701 Cochran Road
Solon, Ohio 44139
Phone: (440) 248-1880
Toll Free: 1-888-331-1523

Temperature Rating	Material	Industry Standards	Series
-22°F to 257°F	C1045/12L14 Steel	SAE J514, ISO 9974	7001-ORR
Pressure Rating	Finish	ASTM B633	Series Description
3600 psi	Trivalent Zinc		SAE J514 37° Flare Male Metric Type (G) Port Adapter