

7000-12-08

Steel, SAE J514 37° Flare Male BSPT Connector, 3/4" Male JIC x 1/2" Male BSPT 30°

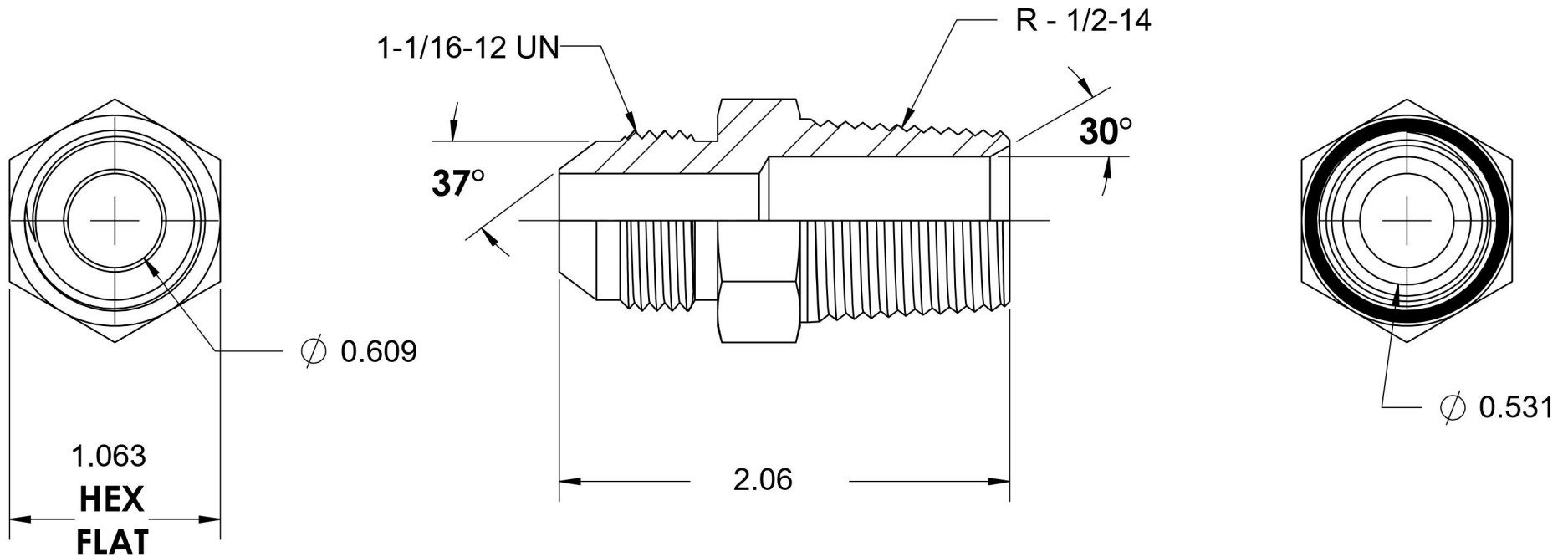

6701 Cochran Road
Solon, Ohio 44139
Phone: (440) 248-1880
Toll Free: 1-888-331-1523

Temperature Rating	Material	Industry Standards	Series
-65°F to 500°F	C1045/12L14 Steel	SAE J514, ISO 7-1	7000
Pressure Rating	Finish	ASTM B633	Series Description
4500 psi	Trivalent Zinc		SAE J514 37° Flare Male BSPT Connector