

0319-04-SS

Stainless Steel, SAE J514 37° Flare Tube Sleeve, 1/4" JIC Tube Sleeve

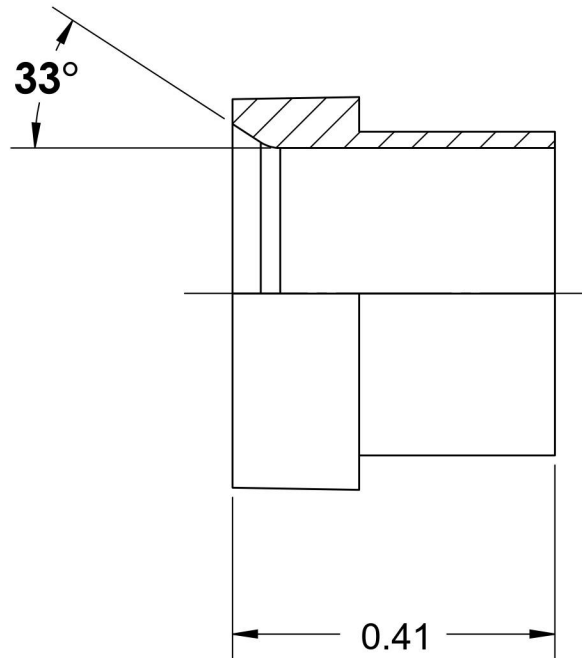
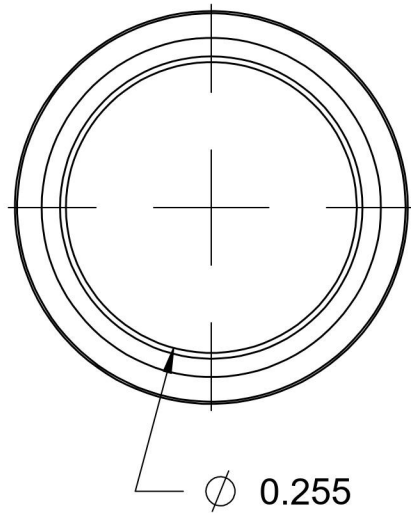

6701 Cochran Road
Solon, Ohio 44139
Phone: (440) 248-1880
Toll Free: 1-888-331-1523

Temperature Rating -425°F to 1200°F	Material 316/316L Stainless Steel	Industry Standards SAE J514	Series 0319-SS
Pressure Rating Not Applicable	Finish Passivated		Series Description SAE J514 37° Flare Tube Sleeve