

2502-06-04-B

Brass, SAE J514 37° Flare 90° Female Elbow, 3/8" Male JIC x 1/4" Female NPTF

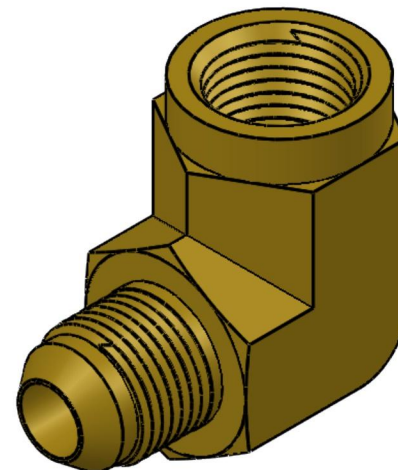
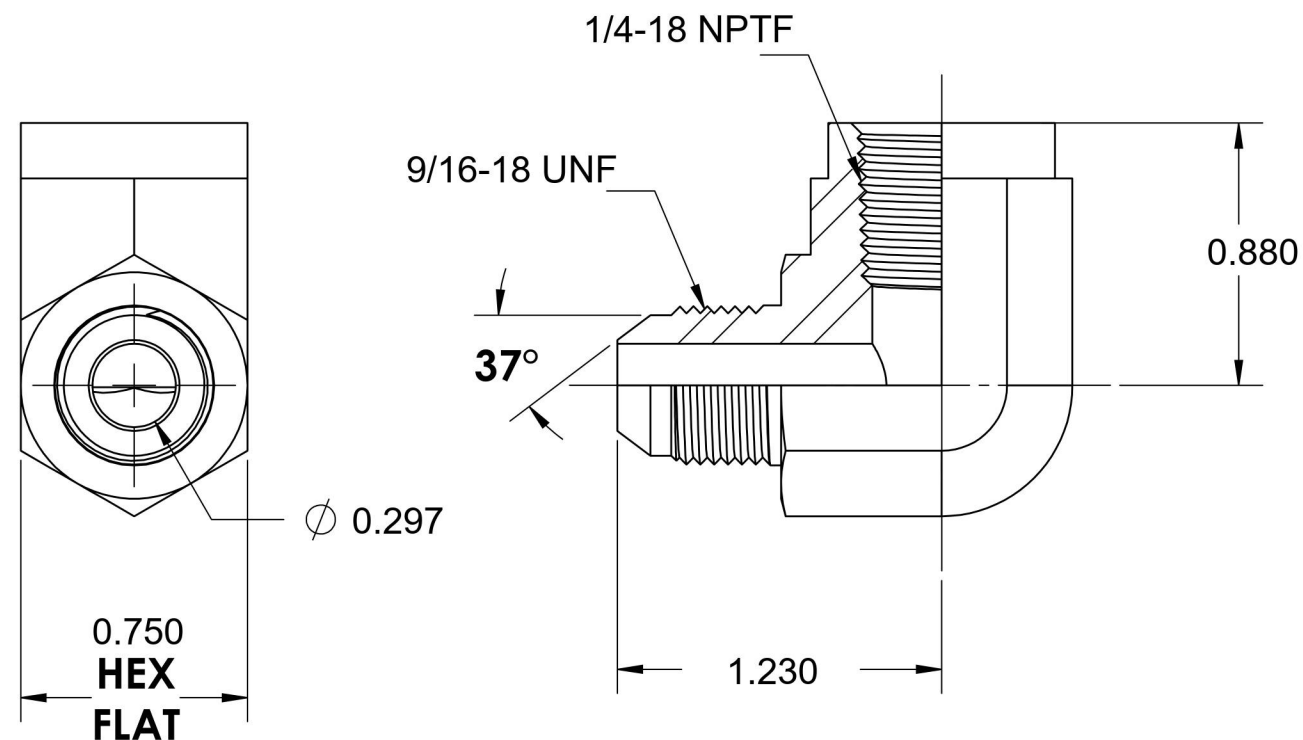

6701 Cochran Road
Solon, Ohio 44139
Phone: (440) 248-1880
Toll Free: 1-888-331-1523

Temperature Rating

-325°F to 400°F

Pressure Rating

3300 psi

Material

CA377 Brass

Finish

Natural Finish

Industry Standards

SAE J514 , SAE J476

Series

2502-B

Series Description

SAE J514 37° Flare
90° Female Elbow