

2501-L-04-04-FG

Steel, SAE J514 37° Flare 90° Long Male Elbow, 1/4" Male JIC x 1/4" Male NPTF 30°

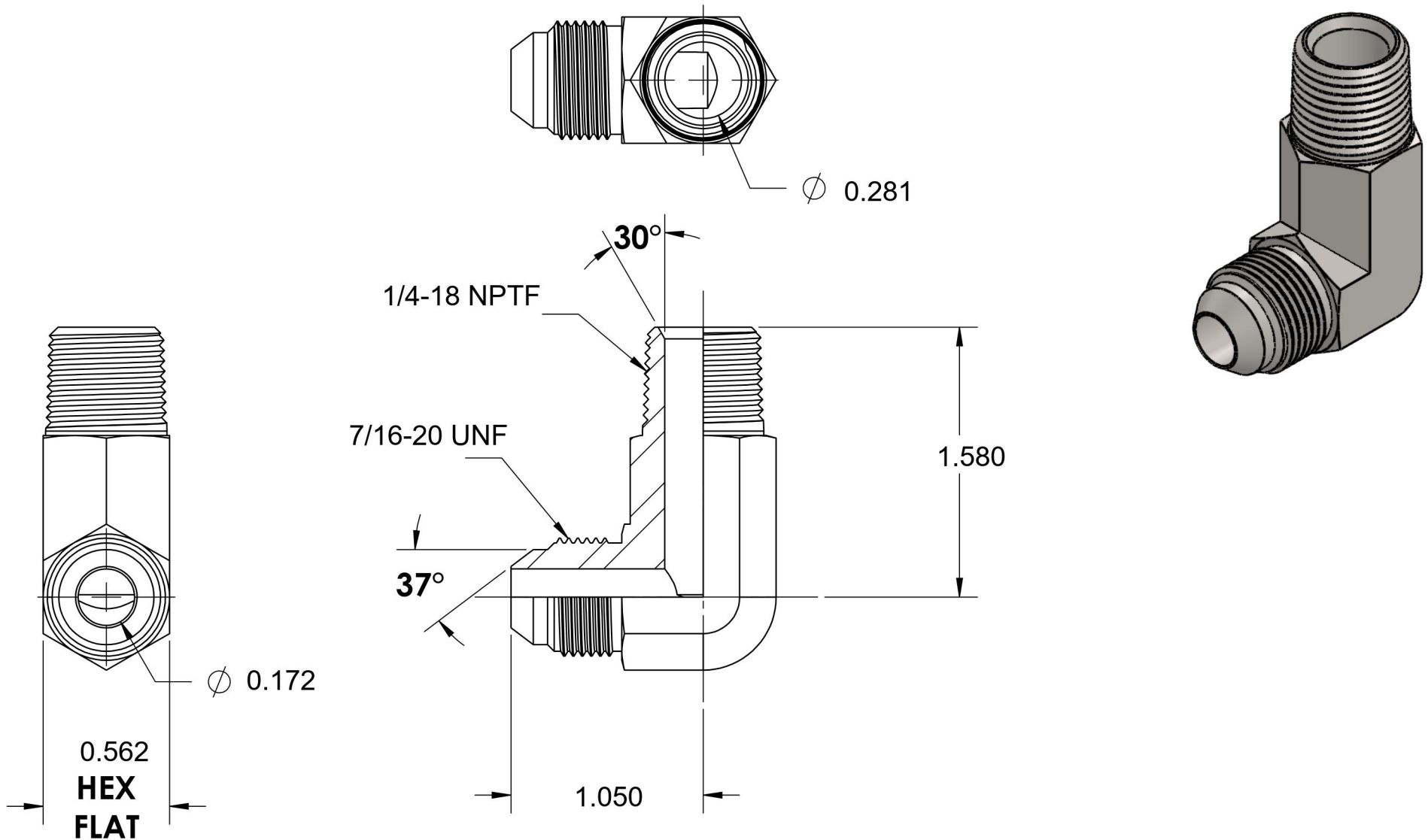

6701 Cochran Road
Solon, Ohio 44139
Phone: (440) 248-1880
Toll Free: 1-888-331-1523

Temperature Rating	Material	Industry Standards	Series
-65°F to 500°F	C1045 Steel	SAE J514 , SAE J476 ASTM B633	2501-L-FG
Pressure Rating	Finish		Series Description
6000psi	Trivalent Zinc		SAE J514 37° Flare 90° Long Male Elbow