

0304-C-08-SS

Stainless Steel, SAE J514 37° Flare Tube Cap, 1/2" Female JIC

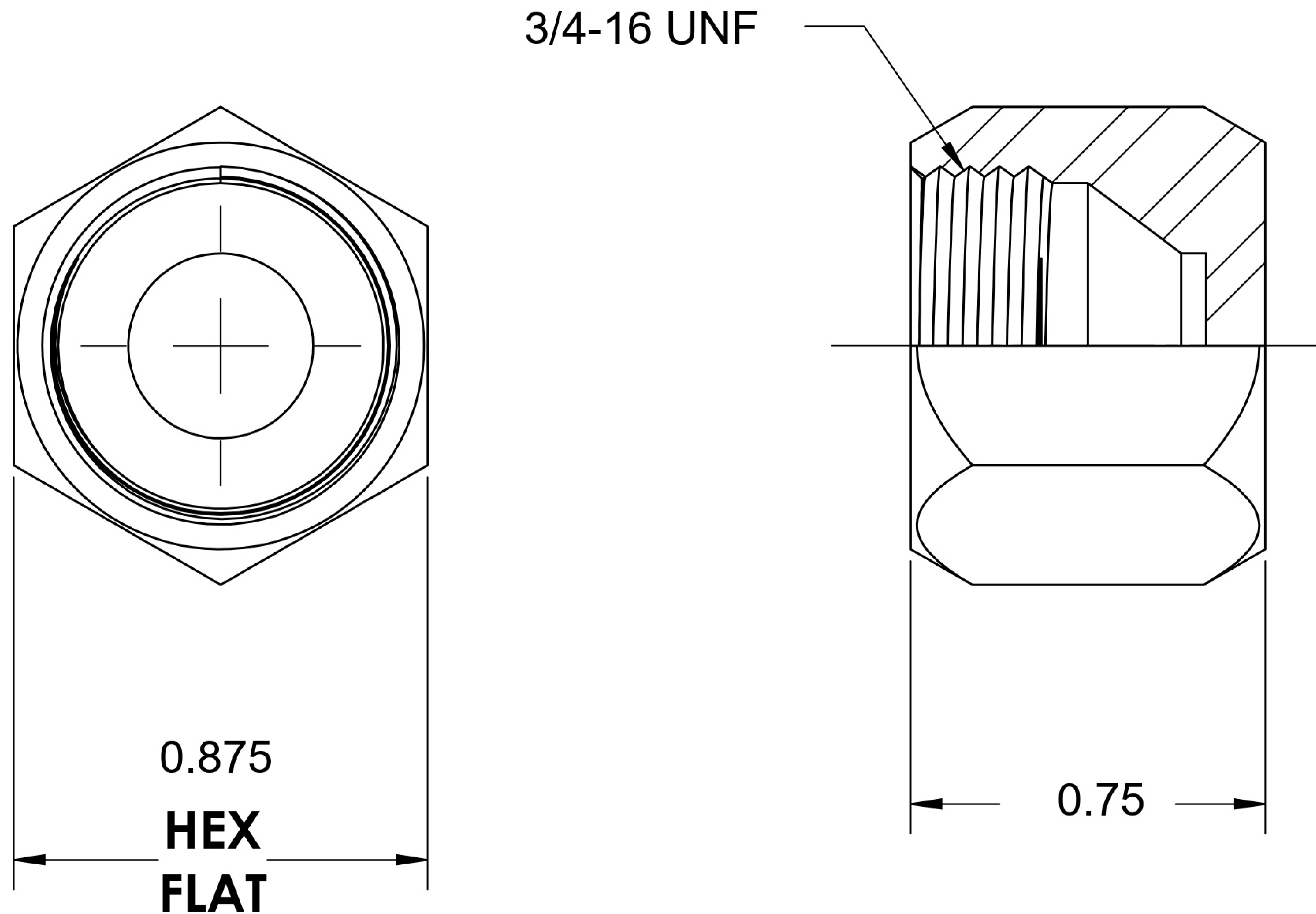
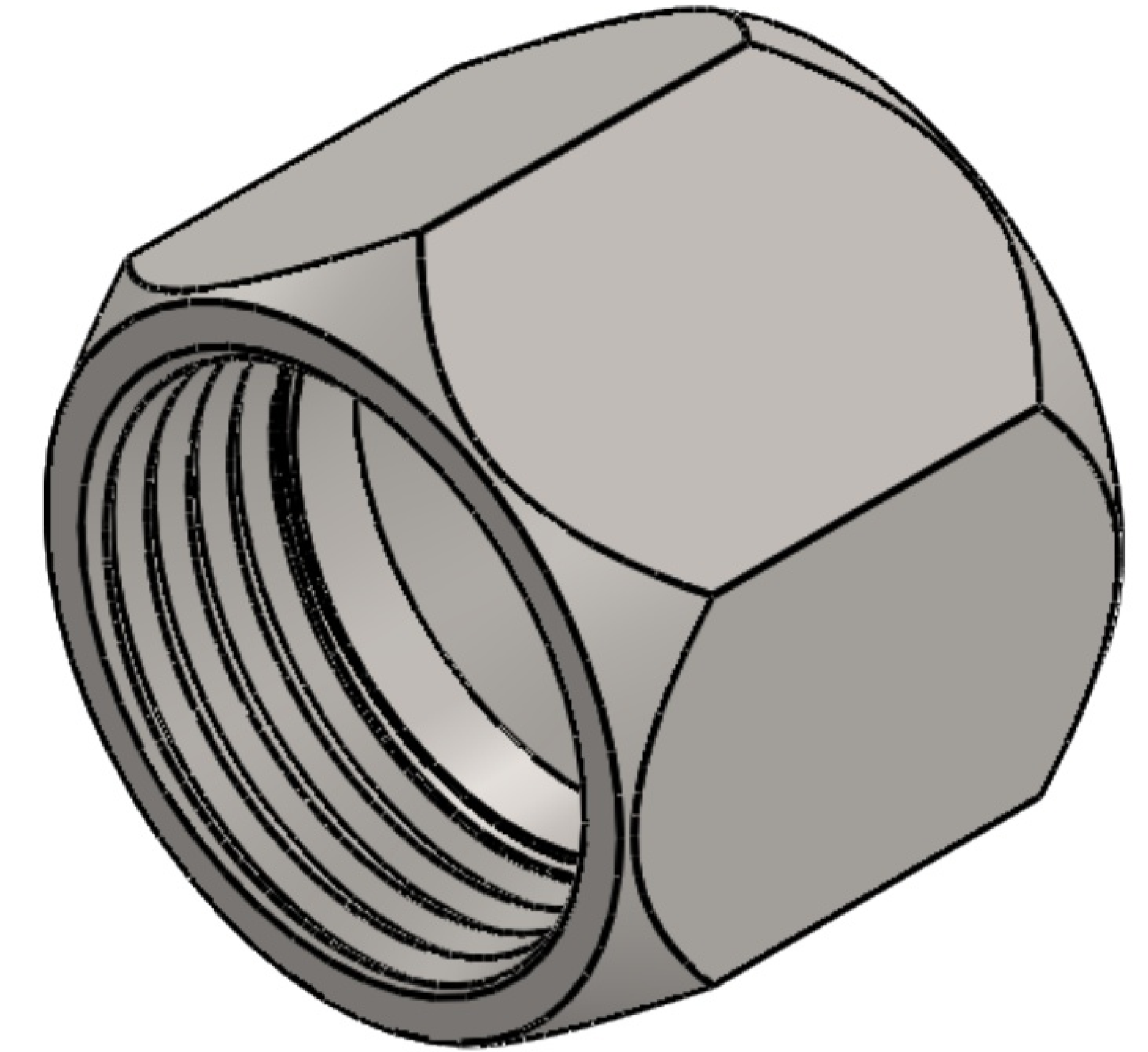

6701 Cochran Road
Solon, Ohio 44139
Phone: (440) 248-1880
Toll Free: 1-888-331-1523

Temperature Rating -425°F to 1200°F	Material 316/316L Stainless Steel	Industry Standards SAE J514	Series 0304-C-SS
Pressure Rating 7200 psi	Finish Passivated		Series Description SAE J514 37° Flare Tube Cap