

7005-10-S12-20-BS

Steel, SAE J514 37° Flare/ISO 8434-1 Heavy Series Male Adapter, Bonded Seal Assembled, 5/8" Male JIC x M20X1.5 Male DIN Line/Tube/Port

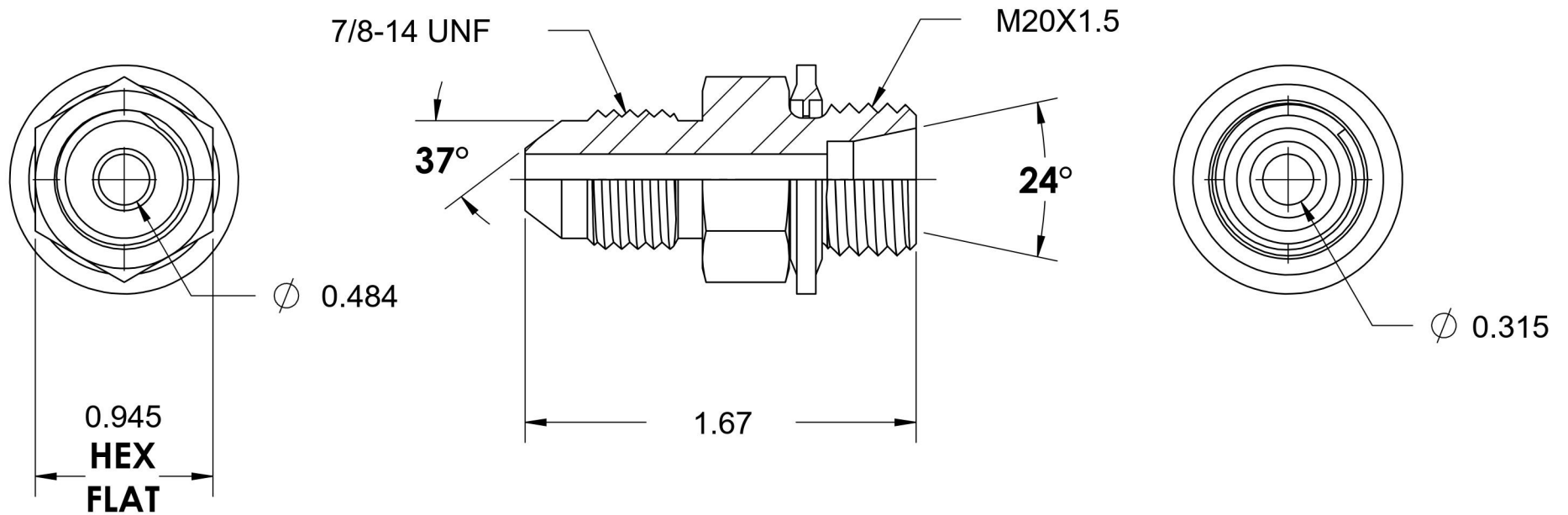
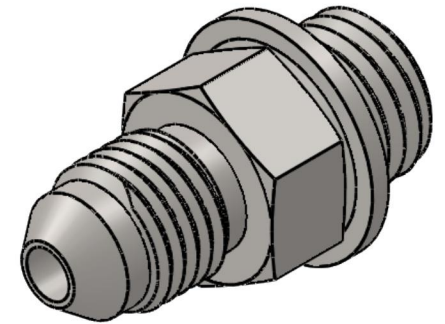

6701 Cochran Road
Solon, Ohio 44139
Phone: (440) 248-1880
Toll Free: 1-888-331-1523

Temperature Rating	Material	Industry Standards	Series
-40°F to 250°F	C1045 / 12L14 Steel	SAE J514, ISO 8434-1	7005-DIN HEAVY-BS
Pressure Rating	Finish	ISO 9974, ASTM B633	Series Description
5000 psi	Trivalent Zinc		SAE J514 37° Flare/ISO 8434-1 Heavy Series Male Adapter Bonded Seal Assembled