

6815-24-24-NWO-SS

Stainless Steel, SAE J1926 Adjustable O-Ring Boss 90° Female Port Elbow, 1-7/8-12 Male Adjustable ORB x 1-7/8-12 Female ORB

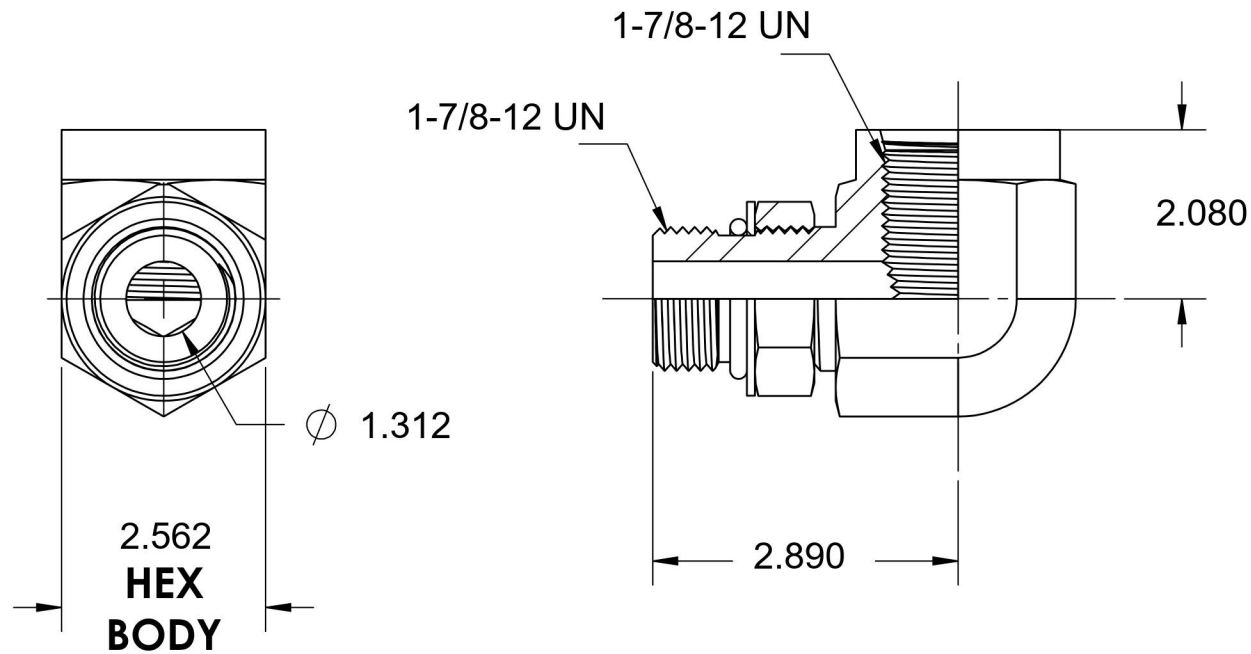
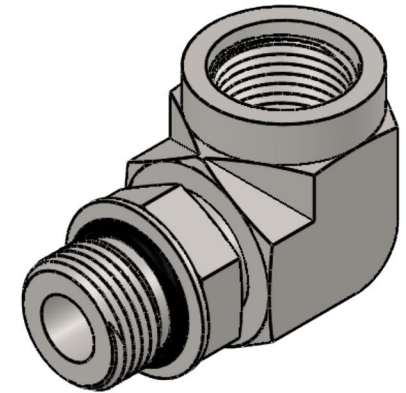
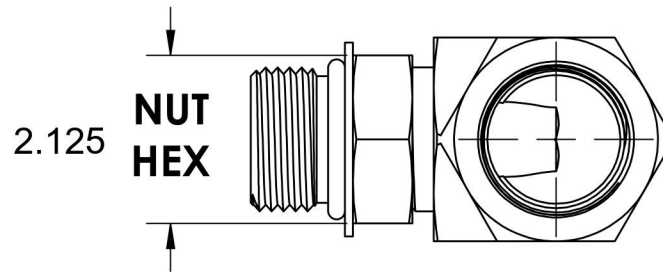

6701 Cochran Road
Solon, Ohio 44139
Phone: (440) 248-1880
Toll Free: 1-888-331-1523

Temperature Rating	Material	Industry Standards	Series
-40°F to 250°F	316/316L Stainless Steel	SAE J1926-1,-3, SAE J515	6815-NWO-SS
Pressure Rating	Finish		Series Description
2000 psi	Passivated		SAE J1926 Adjustable O-Ring Boss 90° Female Port Elbow