

2601-12-12-08-SS

Stainless Steel, SAE J514 SAE J514 37° Flare Male Branch Tee, 3/4" Male JIC x 3/4" Male JIC x 1/2" Male NPTF 30°

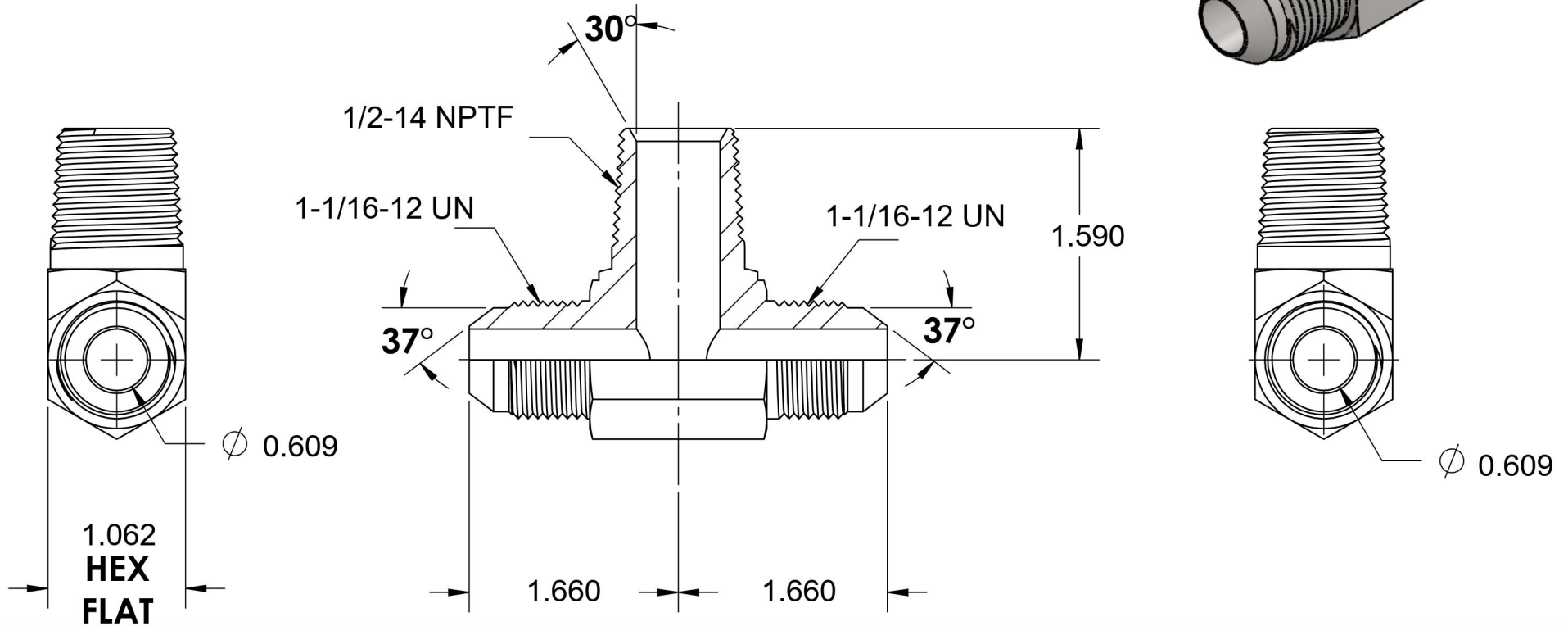
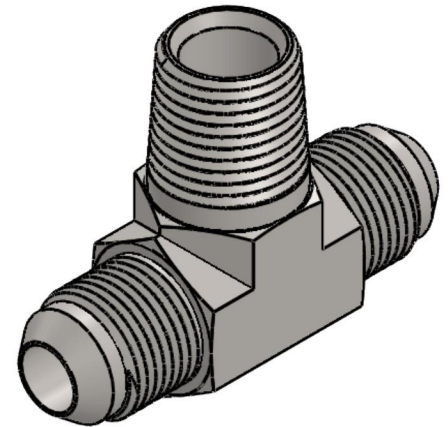
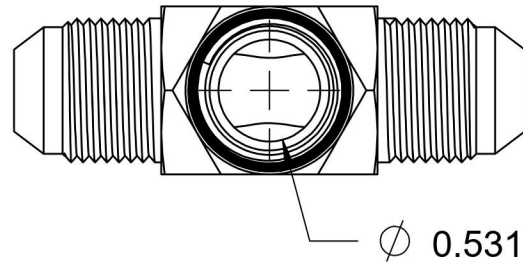

6701 Cochran Road
Solon, Ohio 44139
Phone: (440) 248-1880
Toll Free: 1-888-331-1523

Temperature Rating -425°F to 1200°F	Material 316/316L Stainless Steel	Industry Standards SAE J514 , SAE J476	Series 2601-SS
Pressure Rating 4000 psi	Finish Passivated		Series Description SAE J514 37° Flare Male Branch Tee