

# 7007-08-L15-22-SS

Stainless Steel, SAE J514 37° Flare DIN (L) Swivel Adapter, 1/2" Male JIC x M22X1.5 Female DKO Swivel

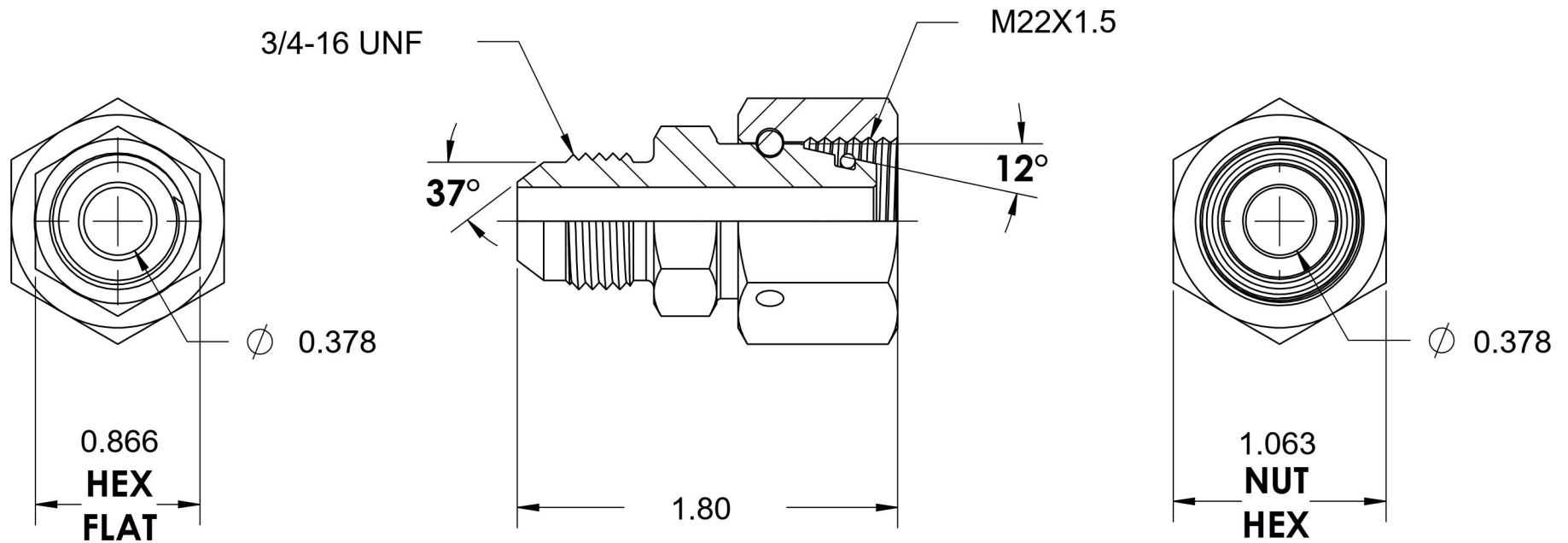

6701 Cochran Road  
Solon, Ohio 44139  
Phone: (440) 248-1880  
Toll Free: 1-888-331-1523

<b>Temperature Rating</b>	<b>Material</b>	<b>Industry Standards</b>	<b>Series</b>
-40°F to 250°F	316/316L Stainless Steel	SAE J514, ISO 8434-1	7007-DIN LIGHT-SS
<b>Pressure Rating</b>	<b>Finish</b>	DIN 2353	<b>Series Description</b>
4500 psi	Passivated		SAE J514 37° Flare DIN (L) Swivel Adapter