

# 6902-08-12-NWO-FG

Steel, SAE J514 NPSM Swivel 45° Adjustable Port Elbow, 3/4-16 Male Adjustable ORB x 3/4" Female NPSM Swivel

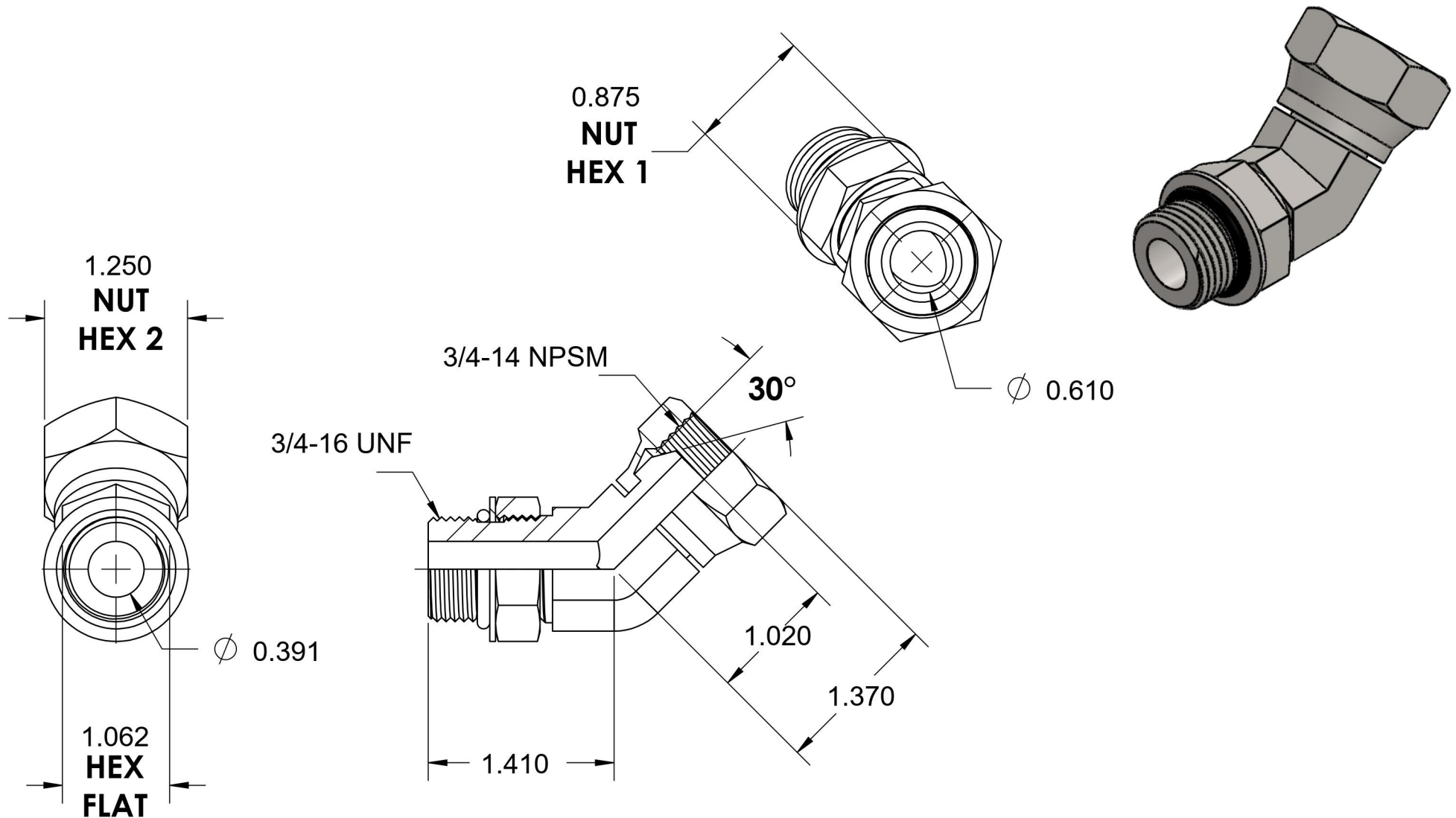

6701 Cochran Road  
Solon, Ohio 44139  
Phone: (440) 248-1880  
Toll Free: 1-888-331-1523

<b>Temperature Rating</b>	<b>Material</b>	<b>Industry Standards</b>	<b>Series</b>
-40°F to 250°F	C1045 Steel	SAE J514, SAE J1926-3 SAE J515, ASTM B633	6902-NWO-FG
<b>Pressure Rating</b>	<b>Finish</b>		<b>Series Description</b>
3000psi	Trivalent Zinc		SAE J514 NPSM Swivel 45° Adjustable Port Elbow