

# 2501-04-12-SS

Stainless Steel, SAE J514 37° Flare 90° Male Elbow, 1/4" Male JIC x 3/4" Male NPTF 30°

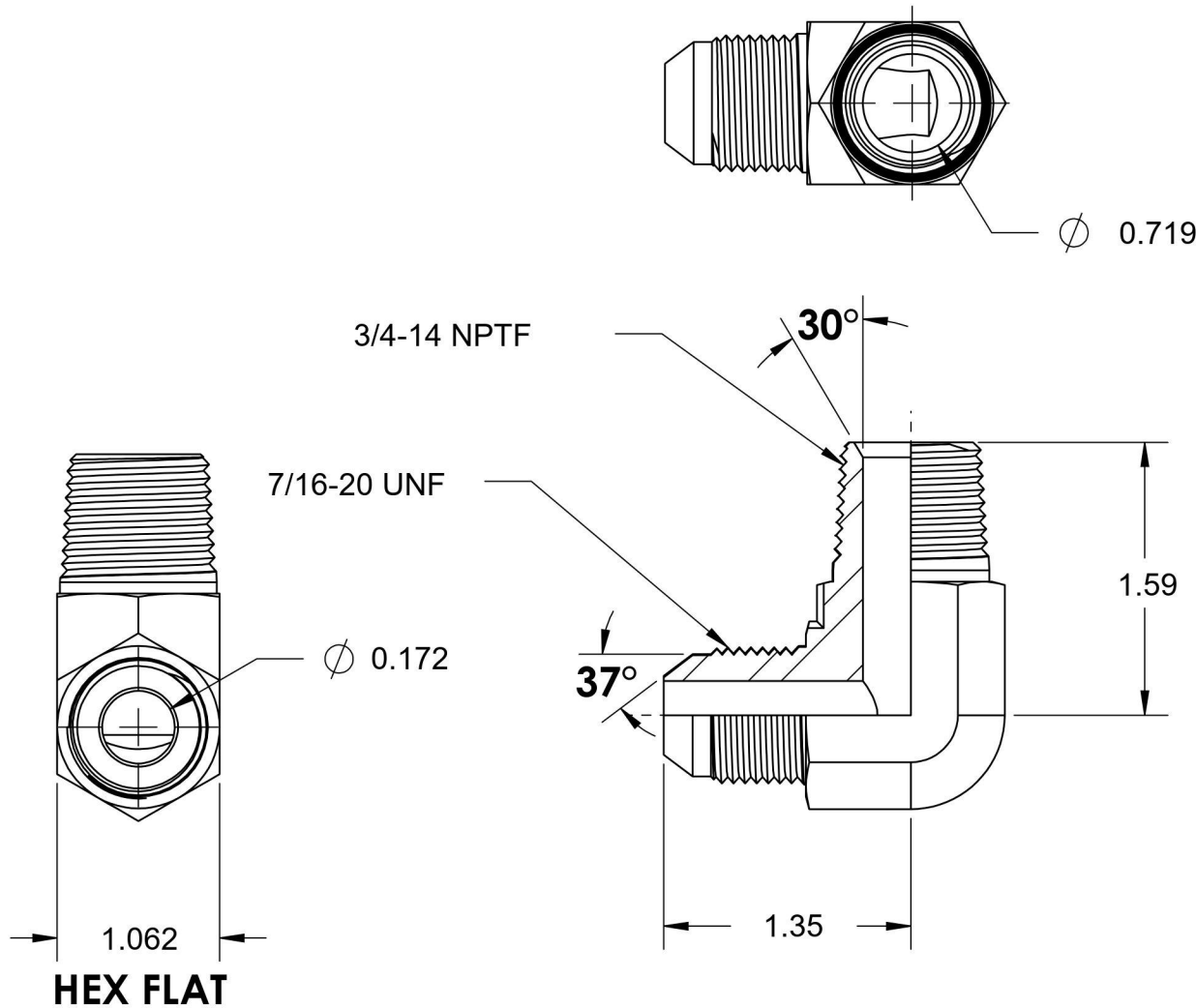

6701 Cochran Road  
Solon, Ohio 44139  
Phone: (440) 248-1880  
Toll Free: 1-888-331-1523

#### Temperature Rating

-425°F to 1200°F

#### Pressure Rating

4000 psi

#### Material

316/316L Stainless Steel

#### Finish

Passivated

#### Industry Standards

SAE J514, SAE J476

#### Series

2501-SS

#### Series Description

SAE J514 37° Flare 90° Male Elbow