

# 2601-08-08-06-SS

Stainless Steel, SAE J514 SAE J514 37° Flare Male Branch Tee, 1/2" Male JIC x 1/2" Male JIC x 3/8" Male NPTF 30°

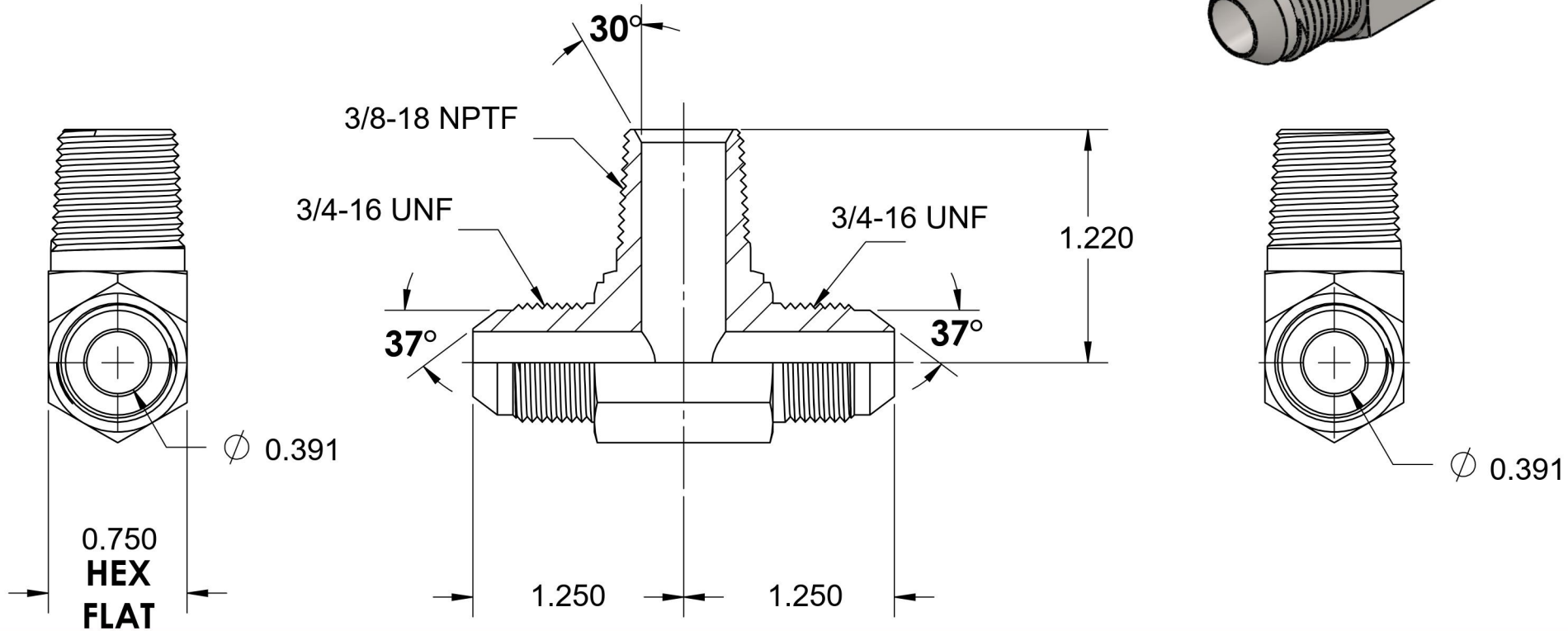
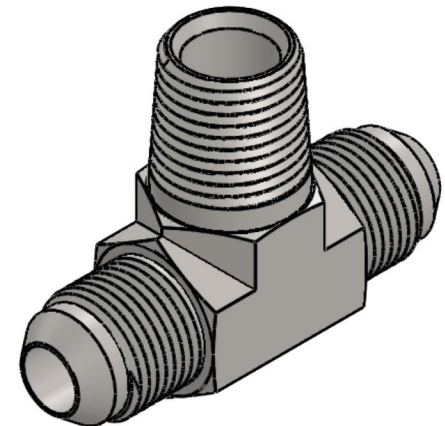
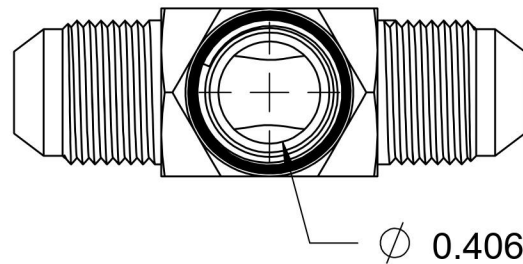

6701 Cochran Road  
Solon, Ohio 44139  
Phone: (440) 248-1880  
Toll Free: 1-888-331-1523

<b>Temperature Rating</b>	<b>Material</b>	<b>Industry Standards</b>	<b>Series</b>
-425°F to 1200°F	316/316L Stainless Steel	SAE J514 , SAE J476	2601-SS
<b>Pressure Rating</b>	<b>Finish</b>		<b>Series Description</b>
6000 psi	Passivated		SAE J514 37° Flare Male Branch Tee