

# D2408-L35-SS-X

Stainless Steel, DIN 2353 Plug, Light 35mm Tube OD, Body Only

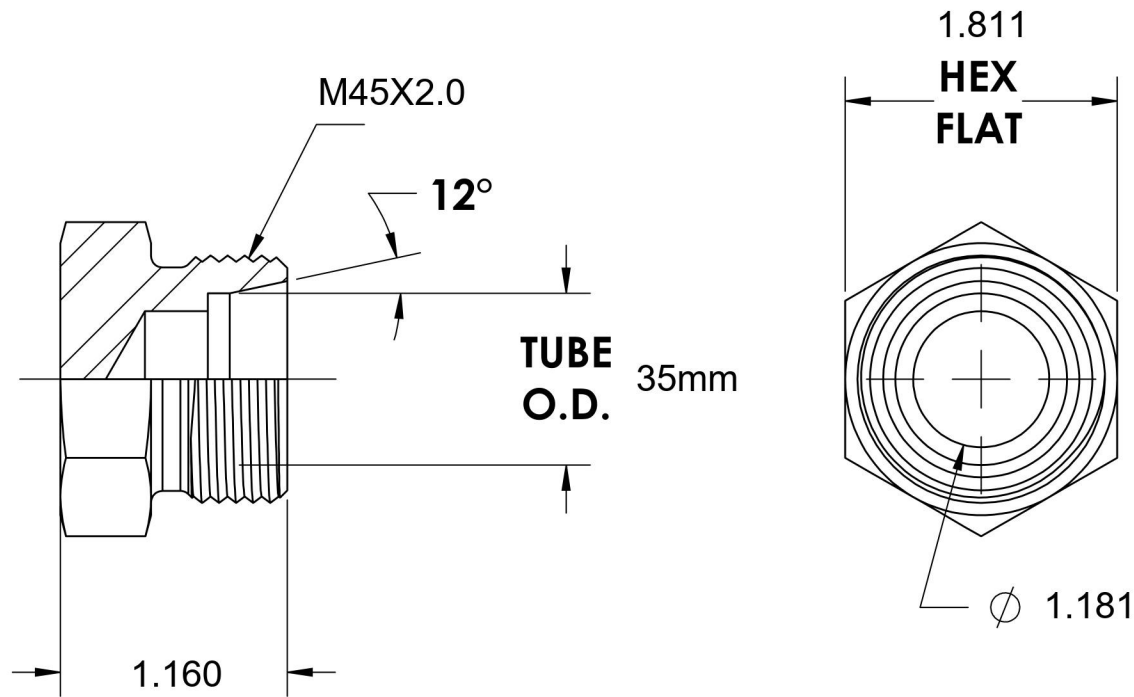
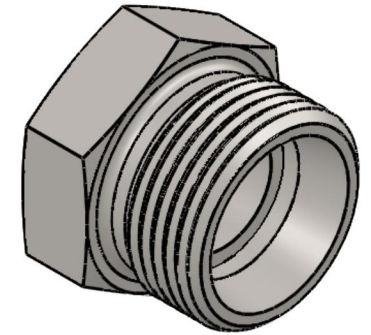

6701 Cochran Road  
Solon, Ohio 44139  
Phone: (440) 248-1880  
Toll Free: 1-888-331-1523

#### Temperature Rating

-425°F to 1200°F

#### Pressure Rating

3626 psi

#### Material

316Ti Stainless Steel

#### Finish

Passivated

#### Industry Standards

DIN 2353, ISO 8434-1

#### Series

D2408-SS-X

#### Series Description

DIN 2353 Flareless  
Tube Plug, Body Only