

5406-C-04-SS

Stainless Steel, SAE J514 Pipe Cap, 1/4" Female NPTF

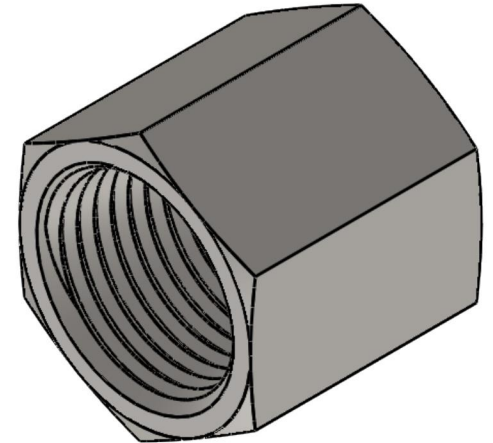
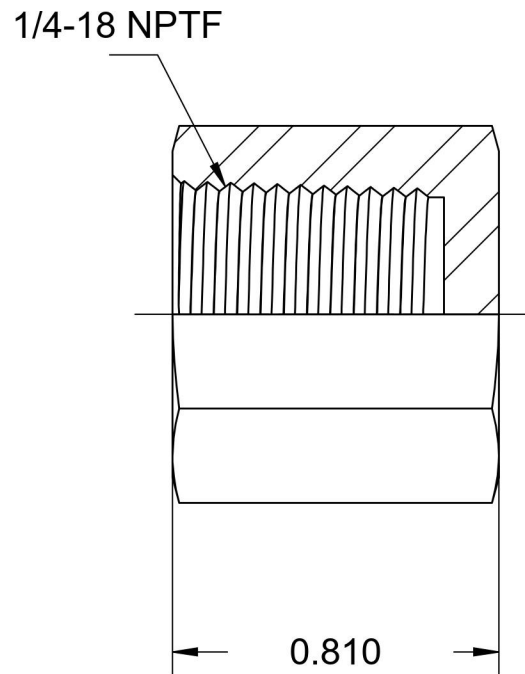
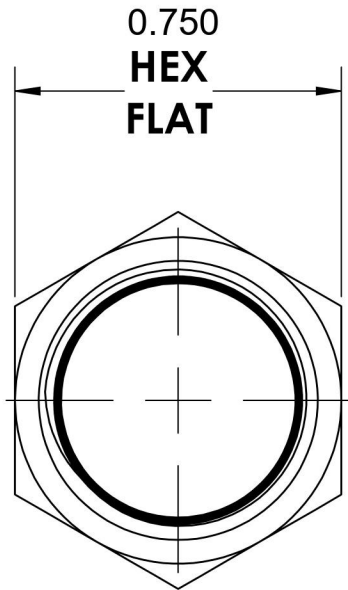

6701 Cochran Road
Solon, Ohio 44139
Phone: (440) 248-1880
Toll Free: 1-888-331-1523

Temperature Rating

-425°F to 1200°F

Pressure Rating

6000 psi

Material

316/316L Stainless Steel

Finish

Passivated

Industry Standards

SAE J514, SAE J476

Series

5406-C-SS

Series Description

SAE J514 Pipe Cap