

C2404-06-06

Steel, SAE J514 Flareless Tube Male Connector, 3/8" Flareless Bite Type x 3/8" Male NPTF 30°

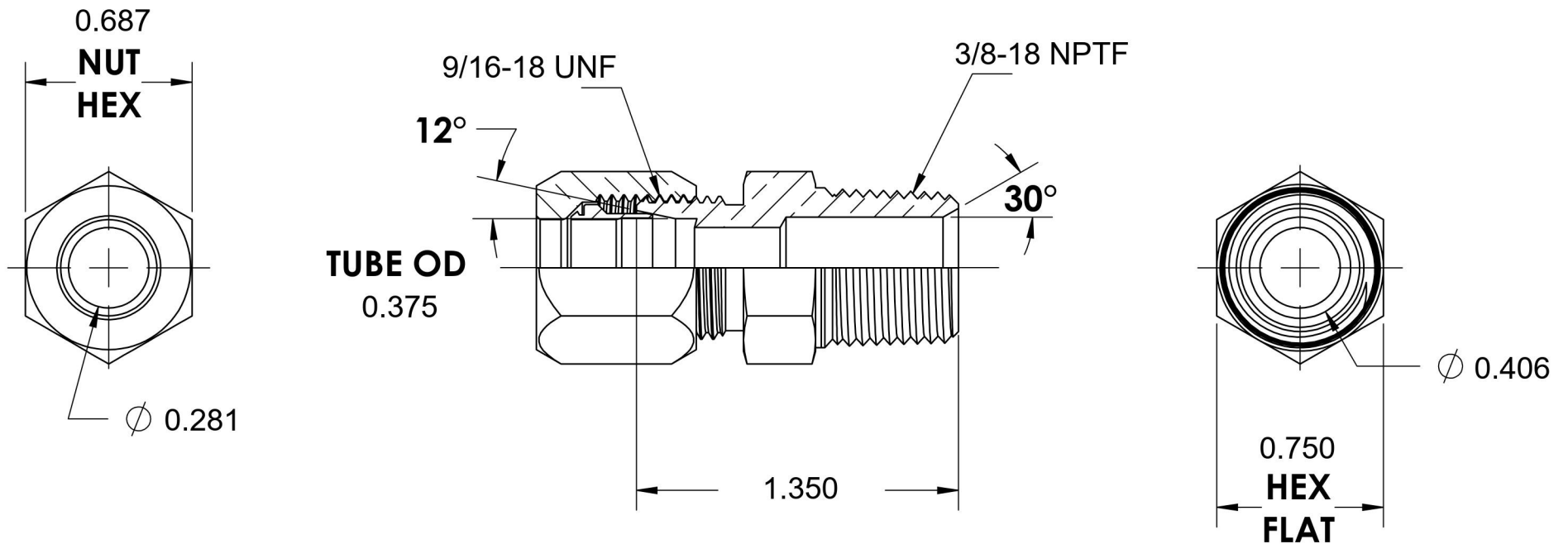
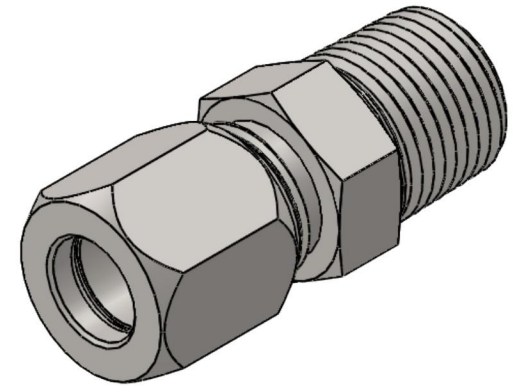

6701 Cochran Road
Solon, Ohio 44139
Phone: (440) 248-1880
Toll Free: 1-888-331-1523

Temperature Rating	Material	Industry Standards	Series
-65°F to 500°F	C1045/12L14 Steel	SAE J514, SAE J476 ASTM B633	C2404
Pressure Rating	Finish		Series Description
6000 psi	Trivalent Zinc		SAE J514 Flareless Tube Male Connector