

6564-10-10-04

Steel, SAE J514 37° Flare Swivel Adapter ORB Diagnostic Port, 5/8" Male JIC x 5/8" Female JIC Swivel x 1/4" FORB Diagnostic Port

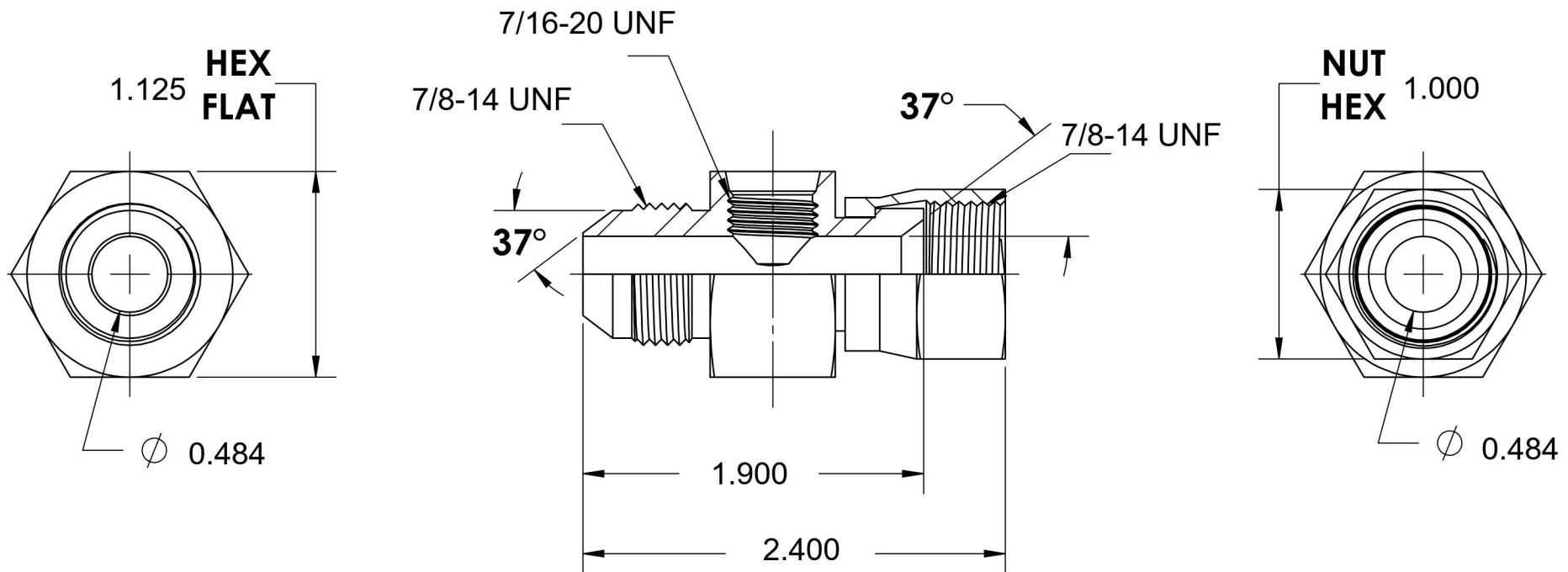
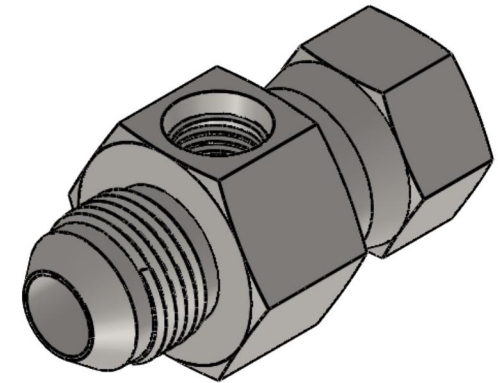

6701 Cochran Road
Solon, Ohio 44139
Phone: (440) 248-1880
Toll Free: 1-888-331-1523

Temperature Rating	Material	Industry Standards	Series
-65°F to 500°F	C1045/12L14 Steel	SAE J514, SAE J1926-1 ASTM B633	6564
Pressure Rating	Finish		Series Description
5000 psi	Trivalent Zinc		SAE J514 37° Flare Swivel Adapter ORB Diagnostic Port