

D2404-S25-16

Steel, DIN 2353 Male Connector, Heavy 25mm Tube OD x 1" NPT

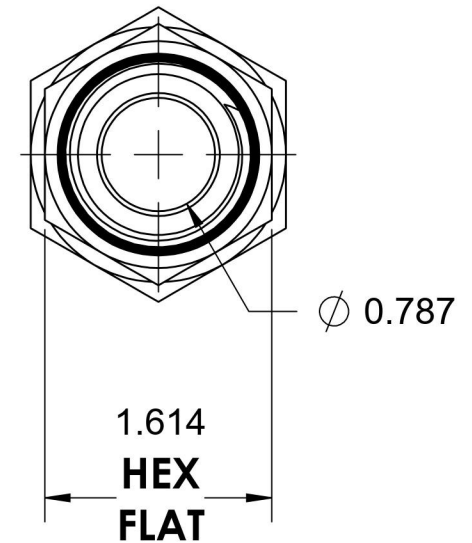
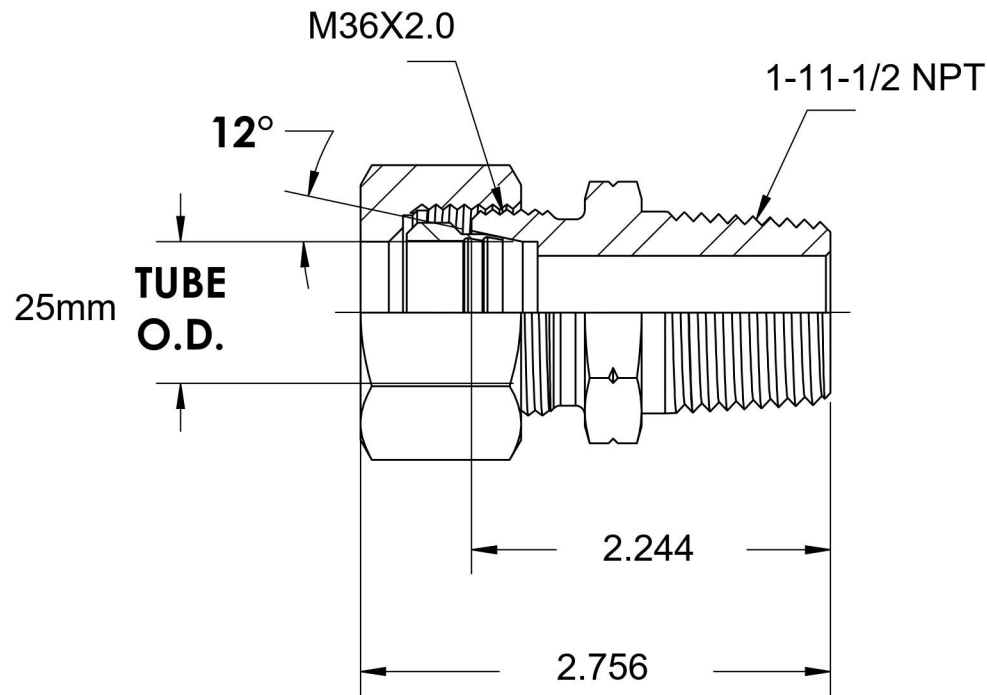
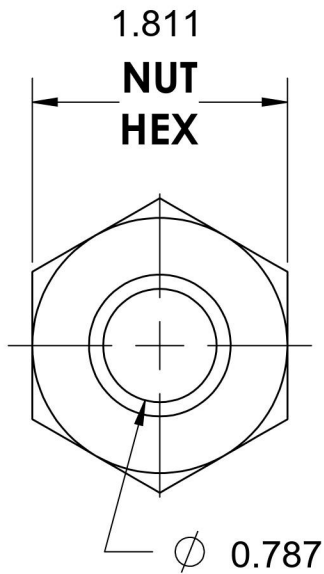
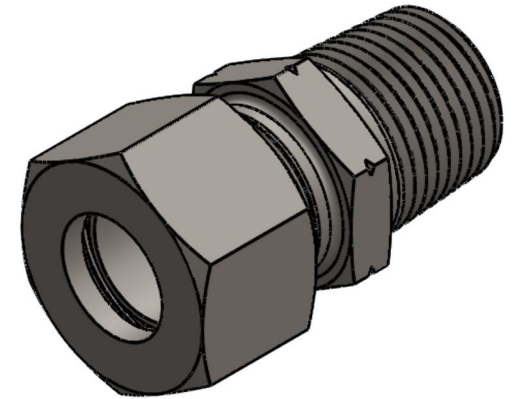

6701 Cochran Road
Solon, Ohio 44139
Phone: (440) 248-1880
Toll Free: 1-888-331-1523

Temperature Rating

-65°F to 500°F

Pressure Rating

5802psi

Material

C22 Steel

Finish

Zinc Nickel

Industry Standards

DIN 2353, ISO 8434-1
ANSI/ASME B1.20.1

Series

D2404

Series Description

DIN 2353 Flareless Tube
Male Connector