

# 2502-06-06-B

Brass, SAE J514 37° Flare 90° Female Elbow, 3/8" Male JIC x 3/8" Female NPTF

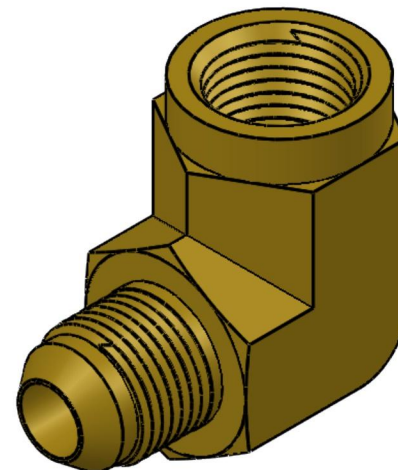
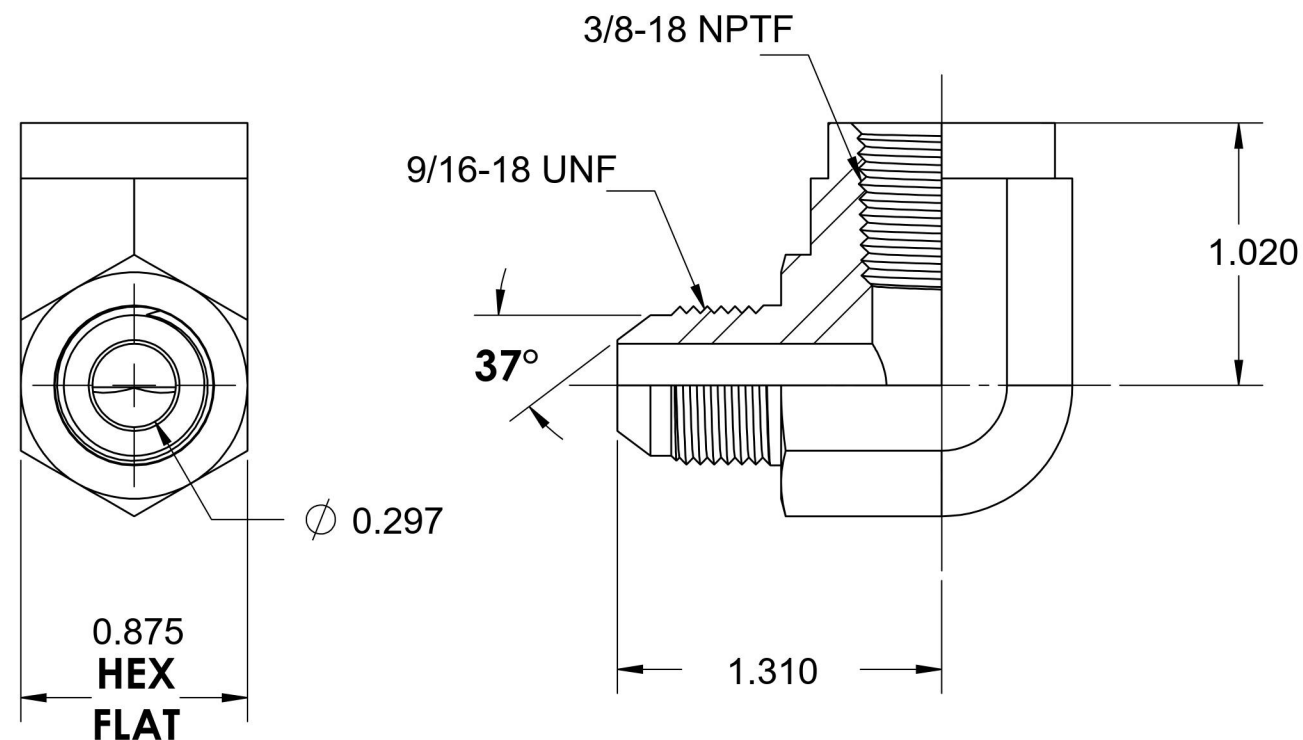

6701 Cochran Road  
Solon, Ohio 44139  
Phone: (440) 248-1880  
Toll Free: 1-888-331-1523

#### Temperature Rating

-325°F to 400°F

#### Pressure Rating

2900 psi

#### Material

CA377 Brass

#### Finish

Natural Finish

#### Industry Standards

SAE J514 , SAE J476

#### Series

2502-B

#### Series Description

SAE J514 37° Flare  
90° Female Elbow