

# C0318-32-SS

Stainless Steel, SAE J514 Flareless Tube Nut, 2" Flareless Bite Type Nut

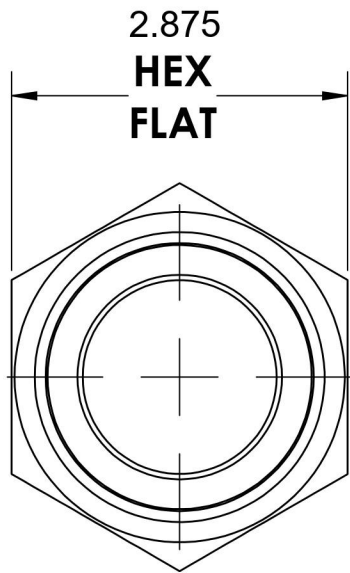

2-1/2-12 UN

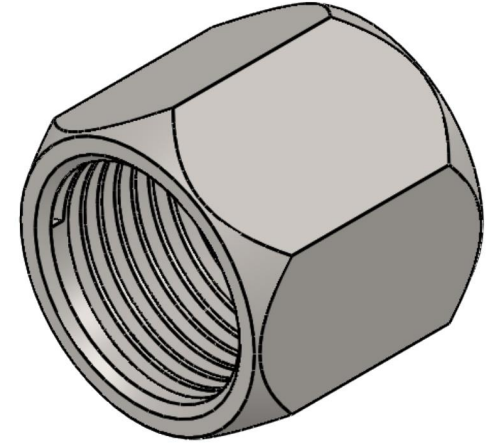
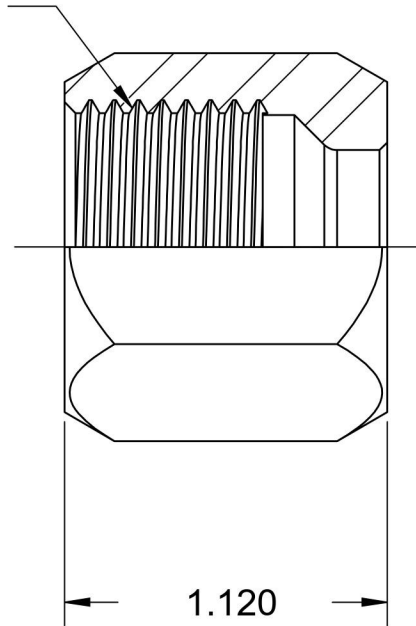

6701 Cochran Road  
Solon, Ohio 44139  
Phone: (440) 248-1880  
Toll Free: 1-888-331-1523

<b>Temperature Rating</b>	<b>Material</b>	<b>Industry Standards</b>	<b>Series</b>
-425°F to 1200°F	316/316L Stainless	SAE J514	C0318
<b>Pressure Rating</b>	<b>Finish</b>		<b>Series Description</b>
Not Applicable	Passivation		SAE J514 Flareless Tube Nut