

FS0306-08

Steel, SAE J1453 O-Ring Face Seal Bulkhead Lock Nut, 1/2" ORFS Locknut

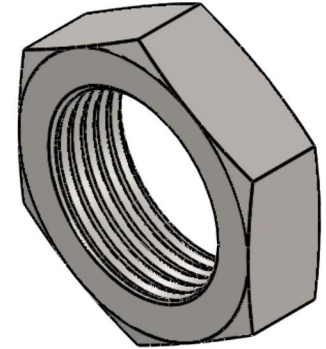
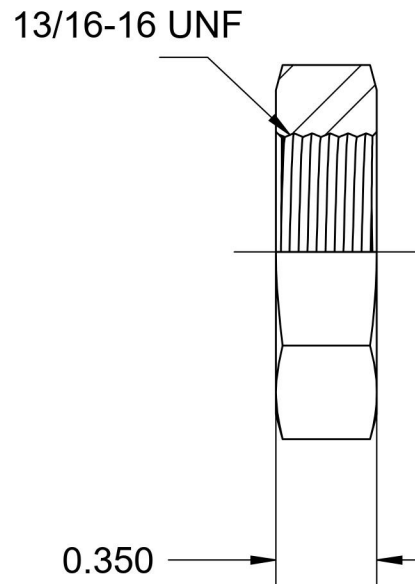
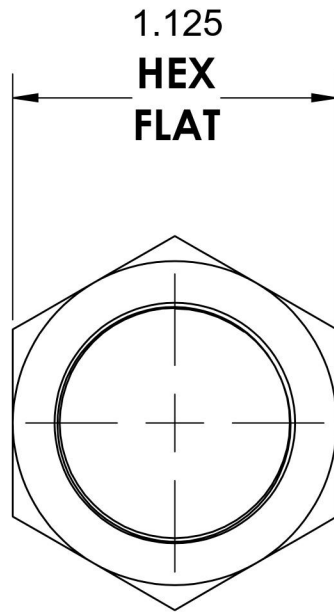

6701 Cochran Road
Solon, Ohio 44139
Phone: (440) 248-1880
Toll Free: 1-888-331-1523

Temperature Rating

-65°F to 500°F

Pressure Rating

Not Available

Material

C1045/12L14 Steel

Finish

Trivalent Zinc

Industry Standards

SAE J1453, ASTM B633

Series

FS0306

Series Description

SAE J1453 O-Ring Face Seal Bulkhead Lock Nut