

6901-06-04-NWO-SS

Stainless Steel, SAE J514 NPSM Swivel 90° Adjustable Port Elbow, 9/16-18 Male Adjustable ORB x 1/4" Female NPSM Swivel

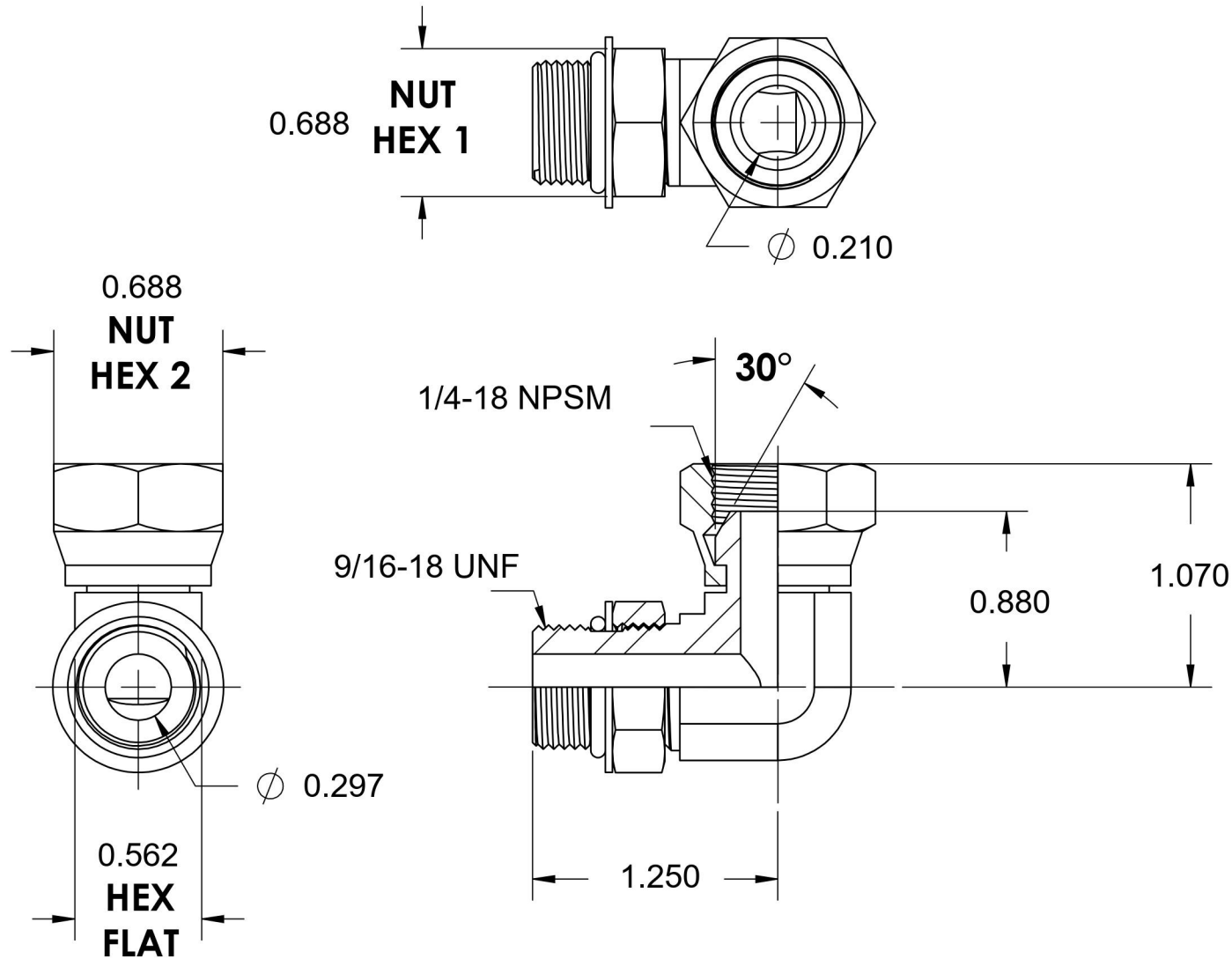

6701 Cochran Road
Solon, Ohio 44139
Phone: (440) 248-1880
Toll Free: 1-888-331-1523

Temperature Rating	Material	Industry Standards	Series
-40°F to 250°F	316/316L Stainless Steel	SAE J514, SAE J1926-3 SAE J515	6901-NWO-SS
Pressure Rating	Finish		Series Description
6000 psi	Passivated		SAE J514 NPSM Swivel 90° Adjustable Port Elbow