

# FS6502-10-10-FG

Steel, SAE J1453 O-Ring Face Seal 45° Swivel Elbow, 5/8" Male ORFS x 5/8" Female ORFS Swivel

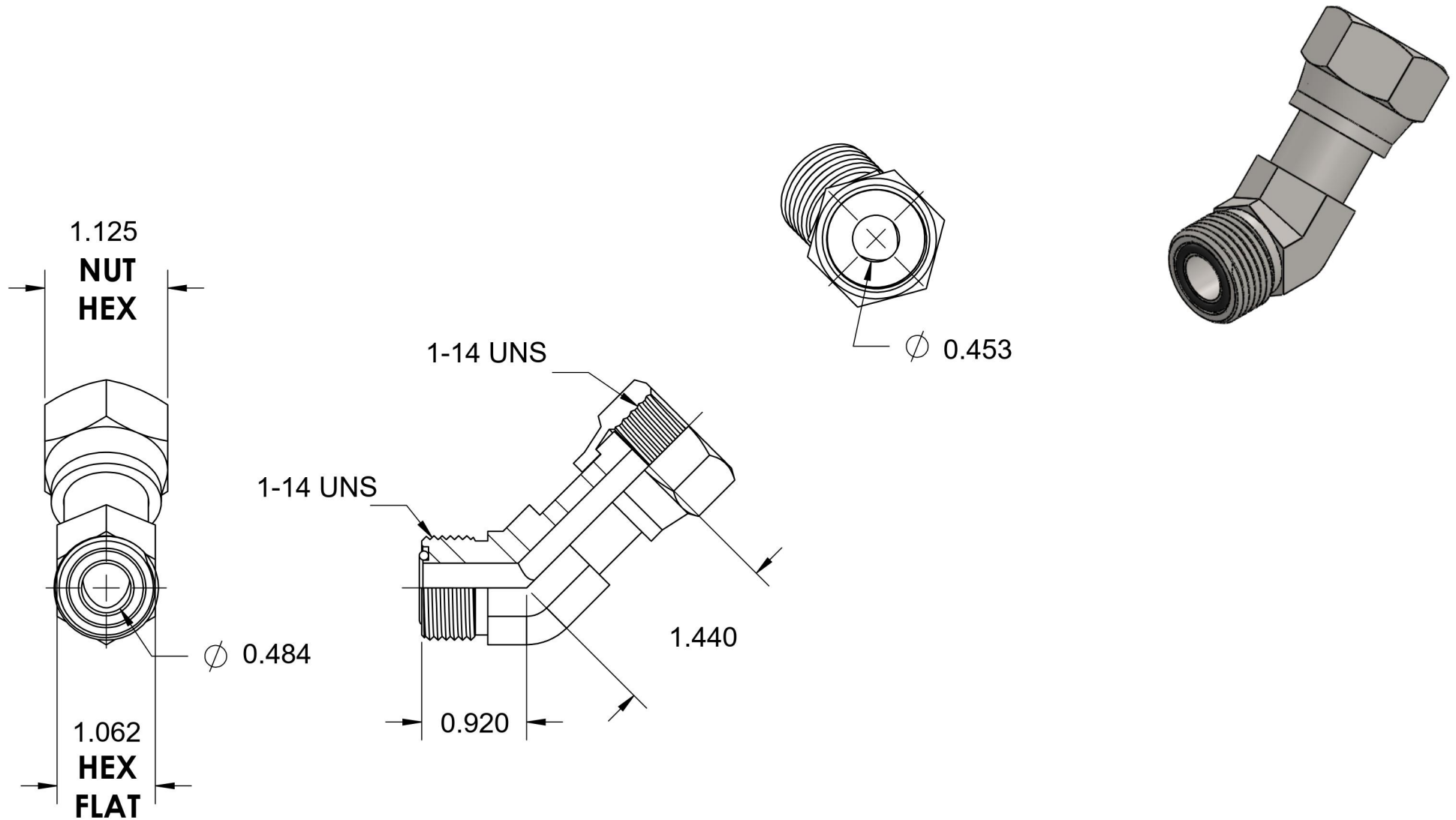

6701 Cochran Road  
Solon, Ohio 44139  
Phone: (440) 248-1880  
Toll Free: 1-888-331-1523

<b>Temperature Rating</b>	<b>Material</b>	<b>Industry Standards</b>	<b>Series</b>
-40°F to 250°F	C1045 Steel	SAE J1453, SAE J515 ASTM B633	FS6502-FG
<b>Pressure Rating</b>	<b>Finish</b>		<b>Series Description</b>
6000 psi	Trivalent Zinc		SAE J1453 O-Ring Face Seal 45° Swivel Elbow