

FS6564-24-24-04

Steel, SAE J1453 O-Ring Face Seal Swivel Adapter ORB Diagnostic Port, 1-1/2" Male ORFS x 1-1/2" Female ORFS Swivel

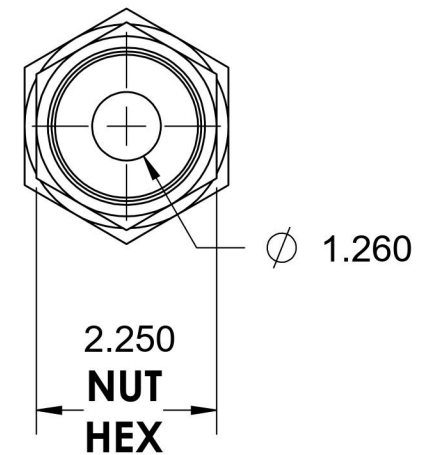
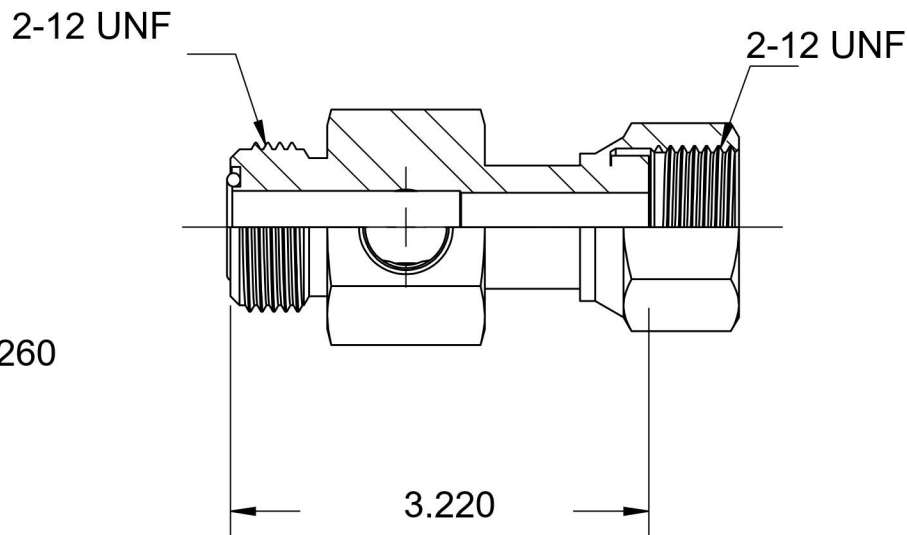
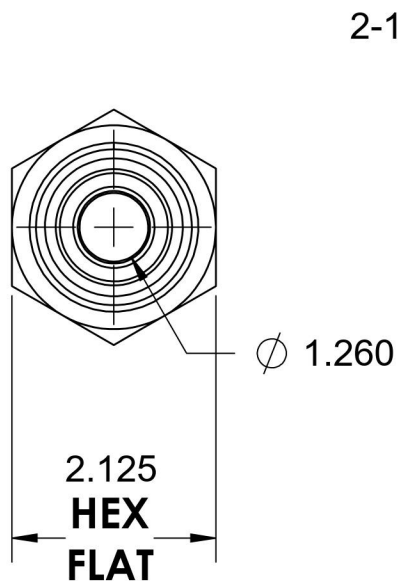
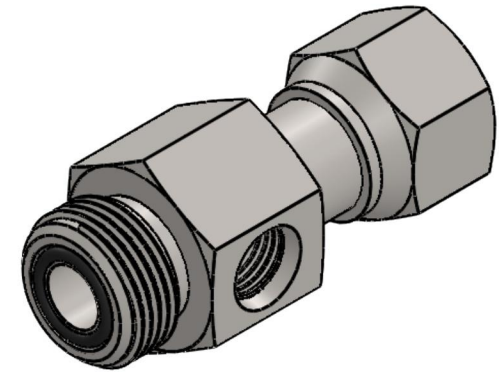
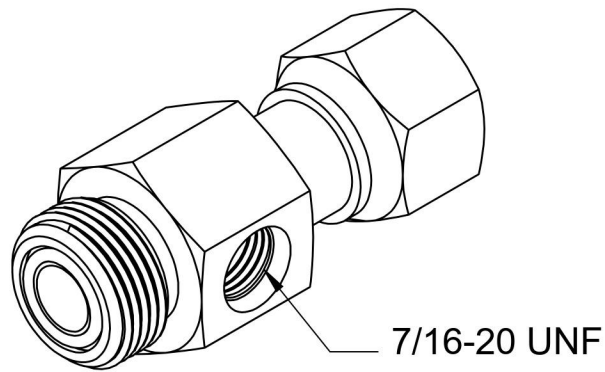

6701 Cochran Road
Solon, Ohio 44139
Phone: (440) 248-1880
Toll Free: 1-888-331-1523

Temperature Rating	Material	Industry Standards	Series
-40°F to 250°F	C1045/12L14 Steel	SAE J1453, SAE J1926-1 ASTM B633	FS6564
Pressure Rating	Finish		Series Description
4000 psi	Trivalent Zinc		SAE J1453 O-Ring Face Seal Swivel Adapter ORB Diagnostic Port