

2706-LN-06-06-SS

Stainless Steel, SAE J514 Flared Tube Male Bulkhead, 3/8" Male NPTF 30° x 1/2" Male JIC

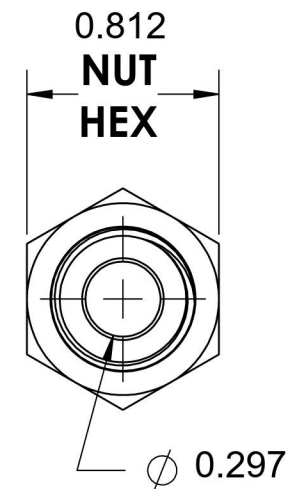
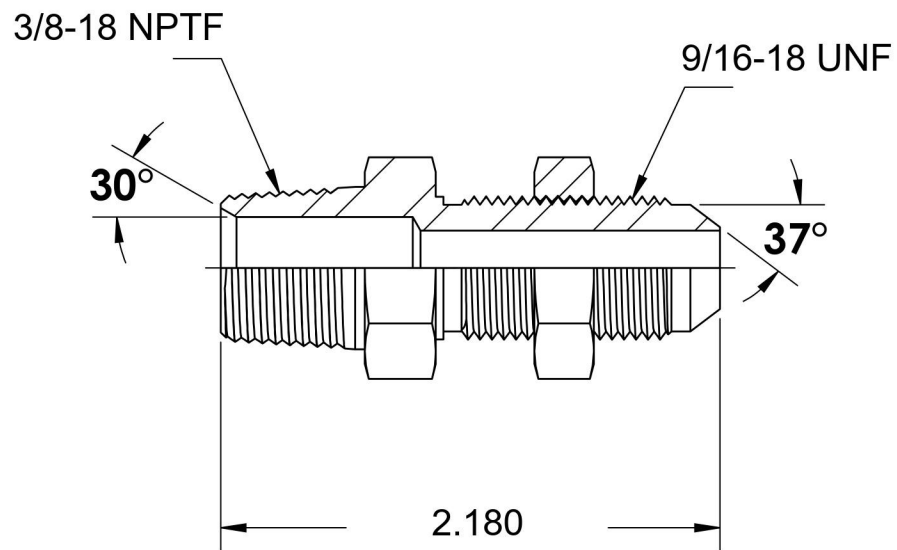
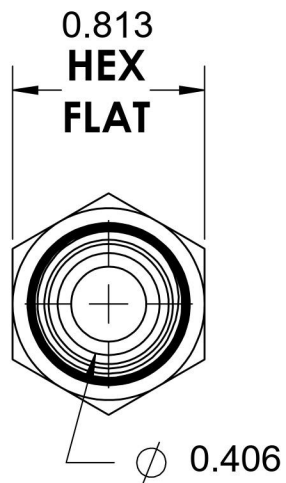
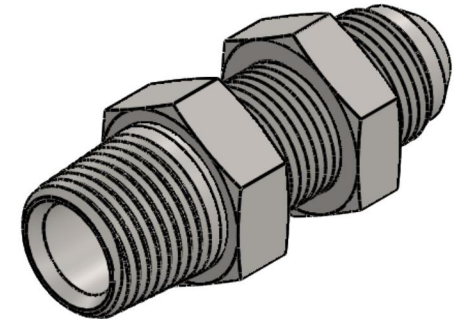

6701 Cochran Road
Solon, Ohio 44139
Phone: (440) 248-1880
Toll Free: 1-888-331-1523

Temperature Rating	Material	Industry Standards SAE J514 , SAE J476	Series 2706-LN-SS
-425°F to 1200°F	316/316L Stainless Steel		
Pressure Rating	Finish		Series Description
6000 psi	Passivated		SAE J514 Flared Tube Male Bulkhead