

6400-10-10-O-VITON

Steel, SAE J514 37° Flare Port Connector, 5/8" Male JIC x 7/8-14 Male ORB, FKM Seal

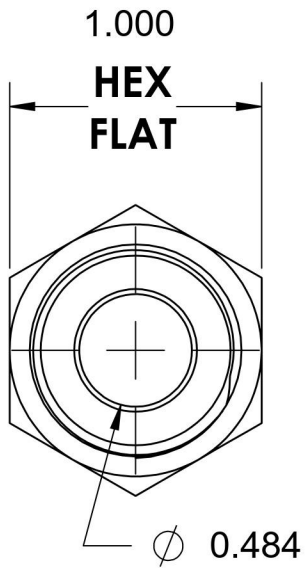

7/8-14 UNF

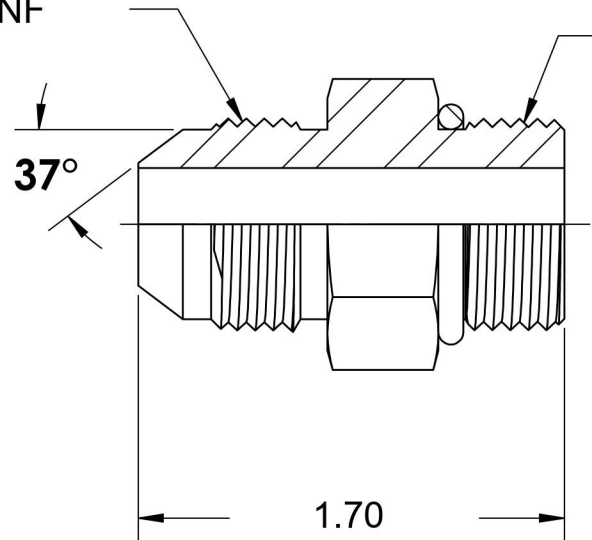

7/8-14 UNF

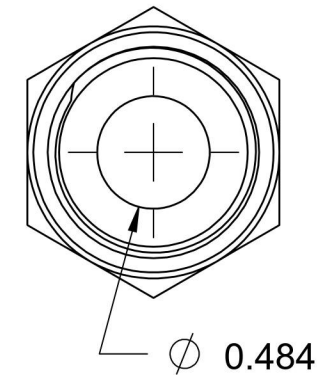

6701 Cochran Road
Solon, Ohio 44139
Phone: (440) 248-1880
Toll Free: 1-888-331-1523

Temperature Rating

-15°F to 400°F

Pressure Rating

5000 psi

Material

C1045 / 12L14 Steel

Finish

Trivalent Zinc

Industry Standards

SAE J514, SAE J1926-3

ASTM B633

Series

6400-O-VITON

Series Description

SAE J514 37° Flare Port Connector