

# 5405-08-12

## Steel, SAE J514 Pipe Expander, 1/2" Male NPTF 30° x 3/4" Female NPTF

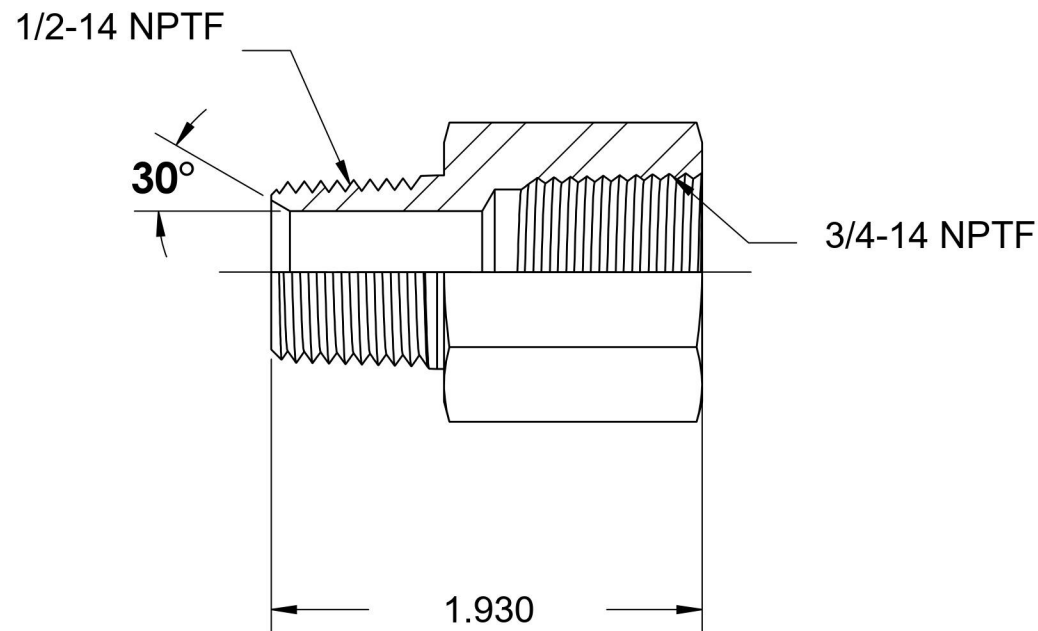
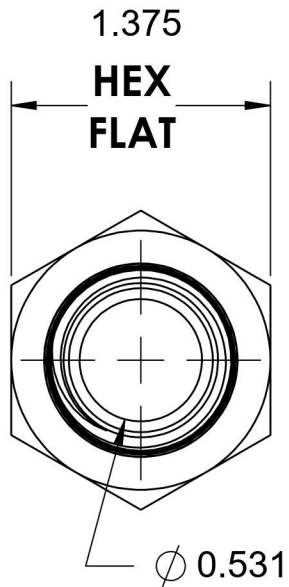

6701 Cochran Road  
Solon, Ohio 44139  
Phone: (440) 248-1880  
Toll Free: 1-888-331-1523

**Temperature Rating**

-65°F to 500°F

**Pressure Rating**

4000 psi

**Material**

C1045/12L14 Steel

**Finish**

Trivalent Zinc

**Industry Standards**

SAE J514 , SAE J476  
ASTM B633

**Series**

5405

**Series Description**

SAE J514 Pipe Expander