

2605-08-08-08-SS

Stainless Steel, SAE J514 37° Flare Male Run Tee, 1/2" Male JIC x 1/2" Male NPTF 30° x 1/2" Male JIC

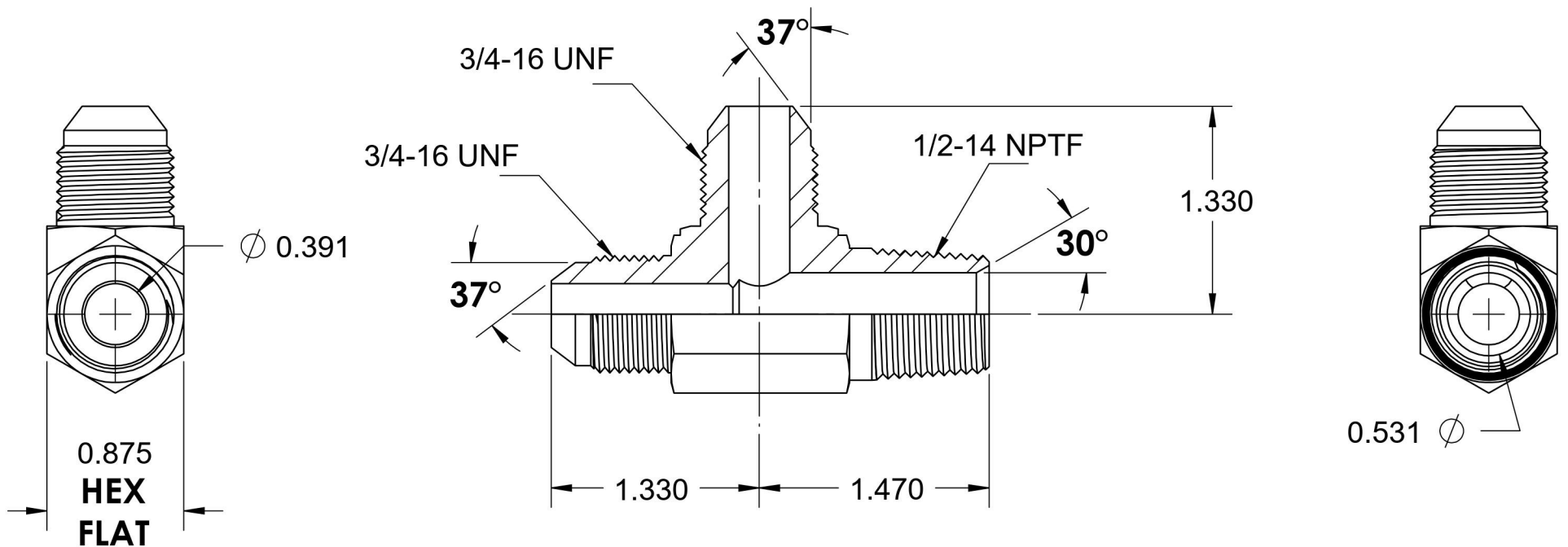
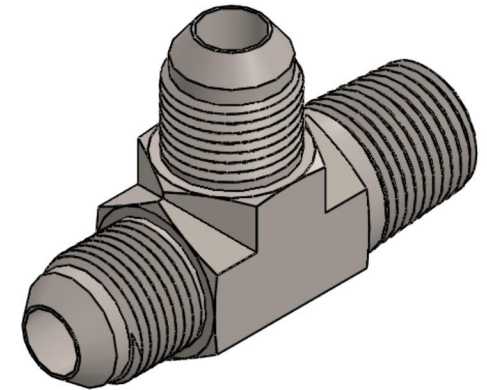
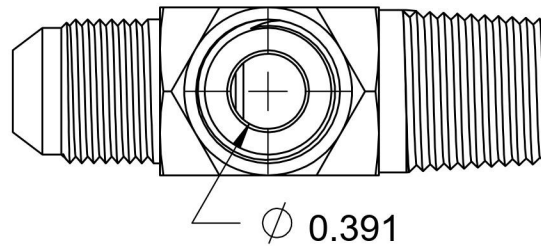

6701 Cochran Road
Solon, Ohio 44139
Phone: (440) 248-1880
Toll Free: 1-888-331-1523

Temperature Rating

-425°F to 1200°F

Material

316/316L Stainless Steel

Industry Standards

SAE J514 , SAE J476

Series

2605-SS

Pressure Rating

6000 psi

Finish

Passivated

Series Description

SAE J514 37° Flare Male Run Tee