

2702-LN-20-20-SS

Stainless Steel, SAE J514 37° Flare Bulkhead 45° Elbow With Lock Nut, 1-1/4" Male JIC x 1-1/4" Male JIC

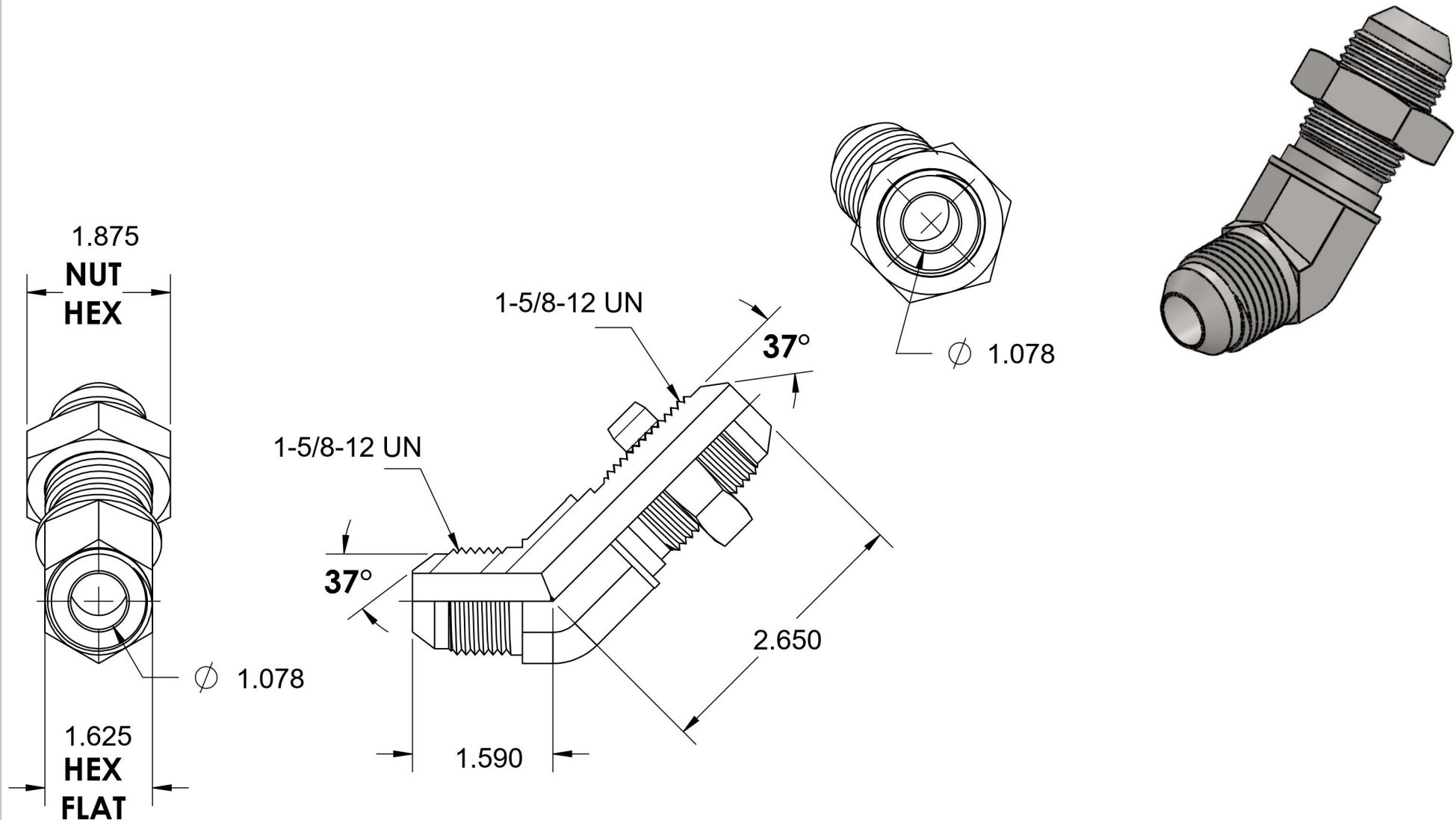

6701 Cochran Road
Solon, Ohio 44139
Phone: (440) 248-1880
Toll Free: 1-888-331-1523

Temperature Rating	Material	Industry Standards	Series
-425°F to 1200°F	316/316L Stainless	SAE J514	2702-LN-FG
Pressure Rating	Finish		Series Description
3000psi	Passivation		SAE J514 37° Flare Bulkhead 45° Elbow With Lock Nut