

6500-04-04-FG

Steel, SAE J514 37° Flare 90° Swivel Elbow, 1/4" Male JIC x 1/4" Female JIC Swivel

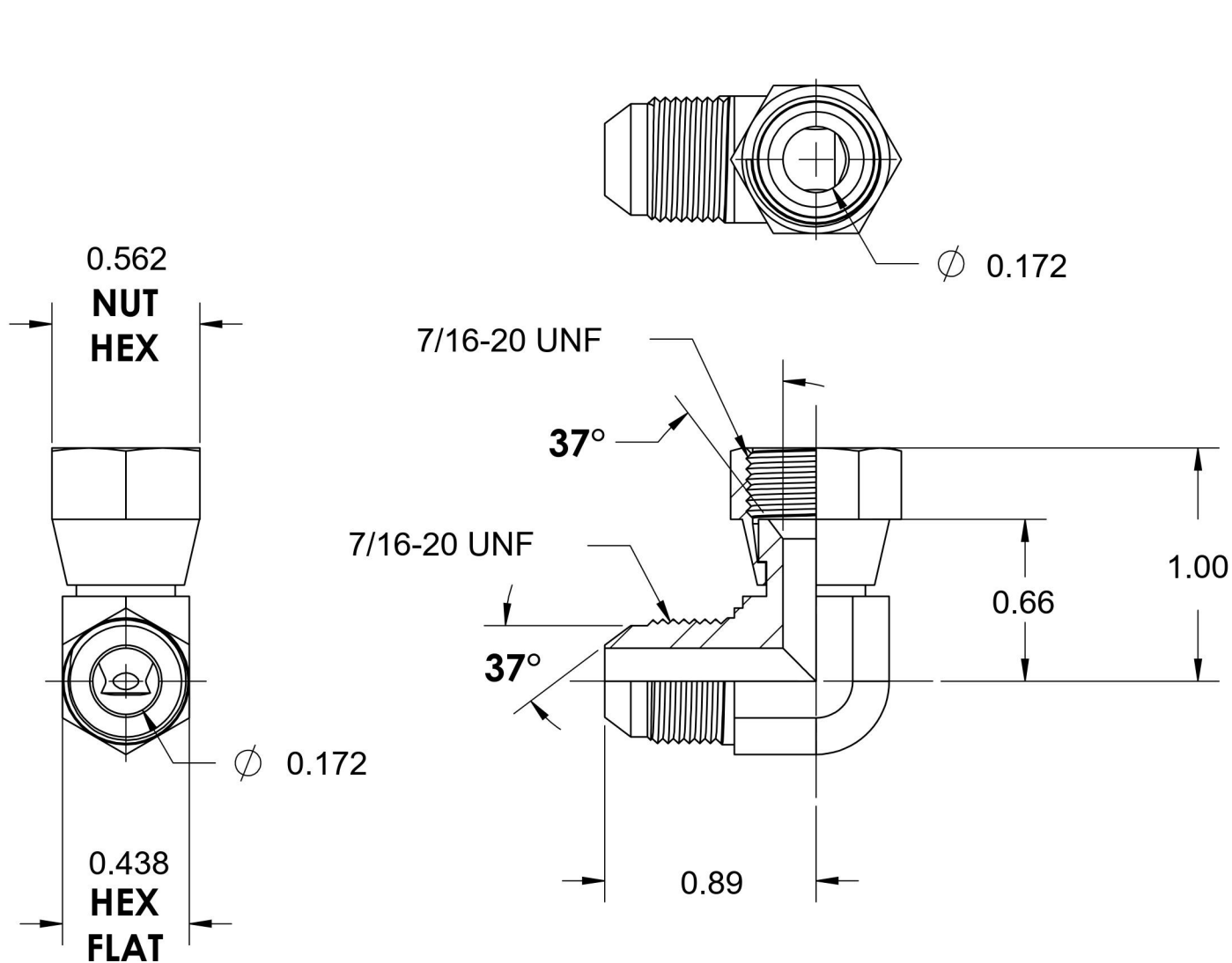

6701 Cochran Road
Solon, Ohio 44139
Phone: (440) 248-1880
Toll Free: 1-888-331-1523

Temperature Rating -65°F to 500°F	Material C1045 Steel	Industry Standards SAE J514, ASTM B633	Series 6500-FG
Pressure Rating 7500 psi	Finish Trivalent Zinc		Series Description SAE J514 37° Flare 90° Swivel Elbow