

7012-10-08-SS

Stainless Steel, SAE J514 37° Flare Male BSPP Type (G) Port Connector, 5/8" Male JIC x 1/2-14 Male BSPP ORR

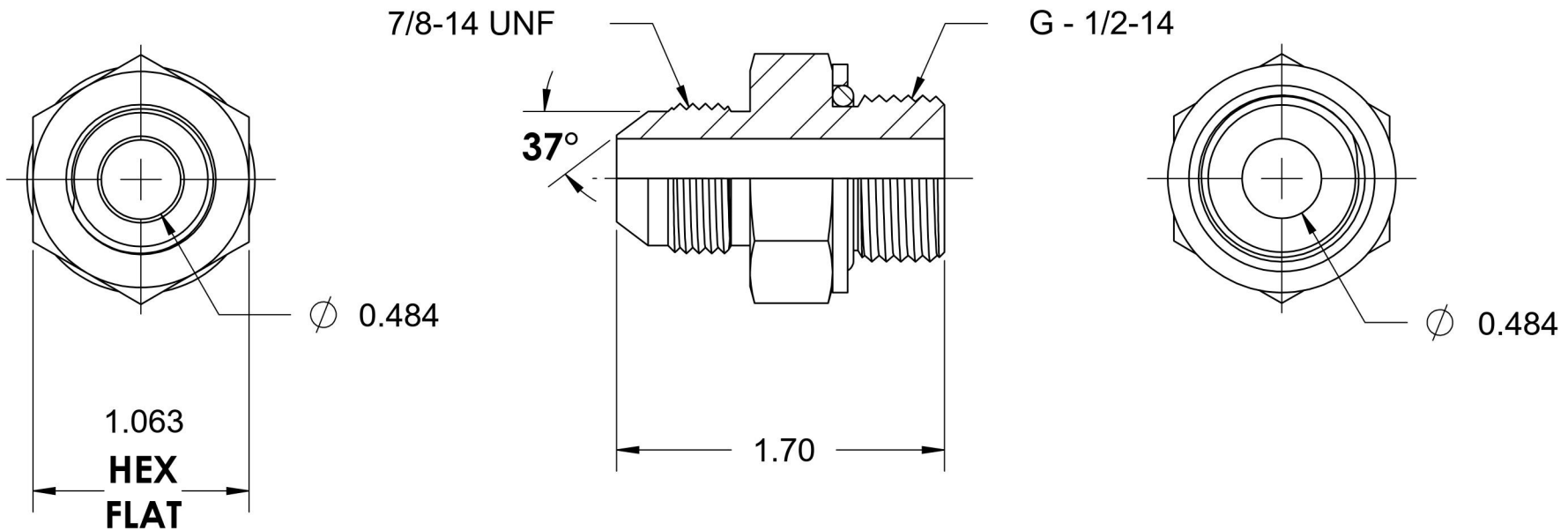
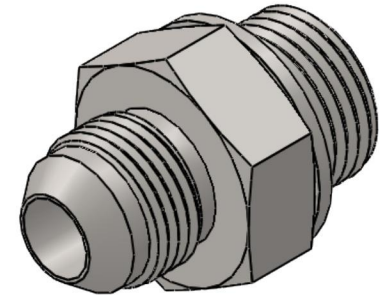

6701 Cochran Road
Solon, Ohio 44139
Phone: (440) 248-1880
Toll Free: 1-888-331-1523

Temperature Rating	Material	Industry Standards	Series
-40°F to 250°F	316/316L Stainless Steel	SAE J514, ISO 1179	7012-ORR-SS
Pressure Rating	Finish		Series Description
5000 psi	Passivated		SAE J514 37° Flare Male BSPP Type (G) Port Connector