

# D2408-S38-X

Steel, DIN 2353 Plug, Heavy 38mm Tube OD, Body Only

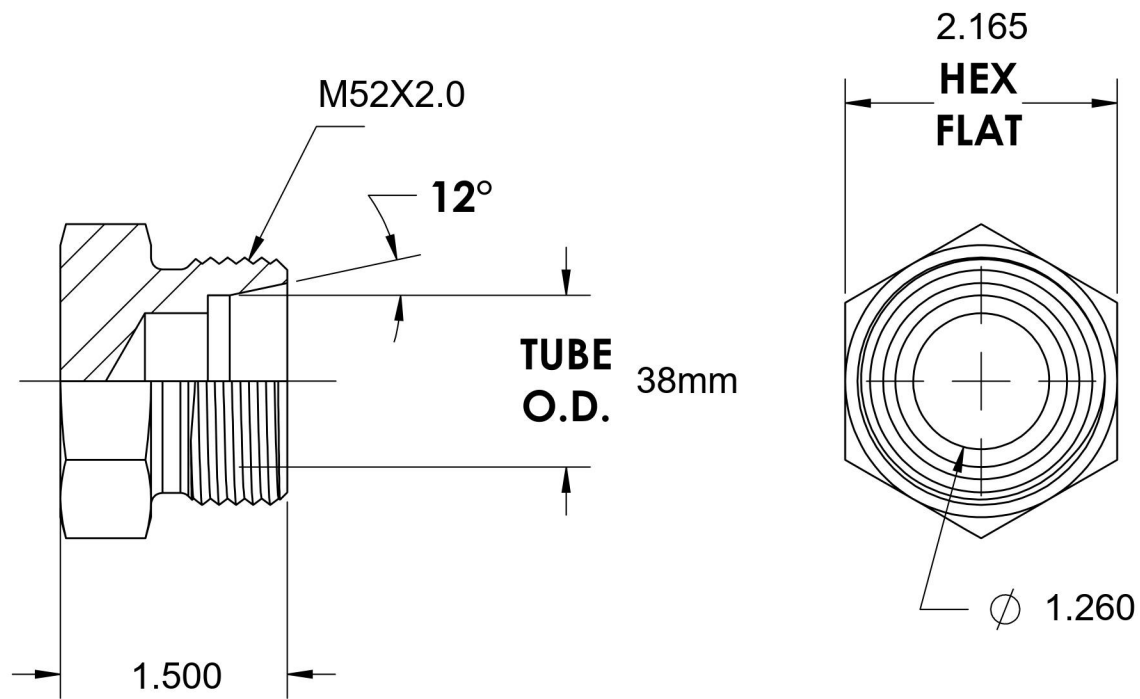
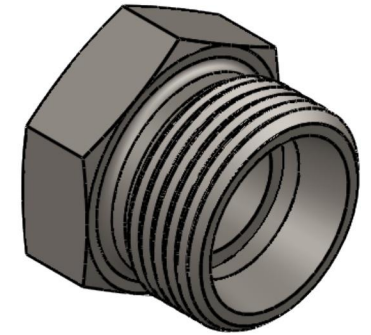

6701 Cochran Road  
Solon, Ohio 44139  
Phone: (440) 248-1880  
Toll Free: 1-888-331-1523

#### Temperature Rating

-65°F to 500°F

#### Pressure Rating

6092 psi

#### Material

C22 Steel

#### Finish

Zinc Nickel

#### Industry Standards

DIN 2353, ISO 8434-1

#### Series

D2408-X

#### Series Description

DIN 2353 Flareless  
Tube Plug, Body Only